

eeelectron®

Building & home evolution



ITALIAN DESIGN

PRODUCTS CATALOGUE



Eelectron designs and manufactures electronic devices in Italy with applications based on KNX®, Bluetooth®, DALI-2® standards and software solutions for the end user.

Eelectron's philosophy is aimed at combining aspects of **design and functional** and performance **research** through highly innovative devices, interoperable on international standards and connected to the cloud.

The **constantly evolving** product portfolio is outlined around the building modernization process, focusing on connected room automation, **Building Evolution**, **hotel automation** and **smart homes**.

Particular attention is paid to the **reliability of products** and to today's **emerging applications**, for the **benefit of occupants** and managers.

In fact, Eelectron's experience is dedicated to the **well-being of people** in buildings and is aimed at those who design, install or manage them in the most sustainable, energy efficient, comfortable and healthy ways.

Pre and post-sales assistance and regular **training** activities are the foundation of a philosophy that places customers and the market at the centre.

Compliance with the strictest **international quality standards** completes Eelectron's vision, which leads the market following its roots and mission: to technologically innovate products, applications and services.

The catalog is constantly updated, we invite you to subscribe to the eelectron newsletter, by visiting the website www.eelectron.com, and follow our social networks.



Eelectron SpA is a Training Center certificated by KNX Association: basic, advanced and HVAC courses.

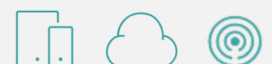



Since its founding in 1994, Eelectron has invested to offer the best technology in building applications:

A shareholder of **KNX Association** (www.knx.org) since 2005:

EIB/KNX is the **interoperable global standard** in the management sector in intelligent, sustainable and healthy buildings, the expression of 500 leading constructors in the sector and with more than 12 million nodes installed worldwide in renovation, extension and new construction projects.

KNX promotes **long-term investment protection** by combining comfort, energy saving, facilitating planning and maintenance with constantly evolving technology: since 2018 it includes the “Secure” standard for security in “building automation” and for the IOT.

Eelectron, as an official **KNX Training Center**, has always disseminated the implementation of good programming guidelines and recommendations for “Secure” aspects.

The portfolio is oriented to “vertical markets”: **tertiary, hospitality, residential, healthcare** proposing specific applications and integrating standard, reliable and safe technologies.

Eelectron products use and interact with **Bluetooth technology** (www.bluetooth.org), both for **wired/wireless** configurations and connected applications such as mobile App and cloud.

The interoperability of KNX promoted by Eelectron is aimed at proposing integrated solutions with other standards, such as recently updated **DALI-2** for modern lighting control (www.dali-alliance.org), or other protocols to meet needs oriented to different market sectors.

Eelectron is a member and active in the aforementioned associations.



INDEX

9025

6

SYNCHRONICITY

38

eSUITE

40

3025

42

TOUCH PANEL

44

MINIPAD

48

HORIZONE

50

ACTUATORS

56

Design Controls

Research, development, design, production. Made in Italy

9025

evolving skills

9025 KNX is a set of touch switches, a range dedicated to temperature management, and a technological system to control smart buildings.

DESIGN PLUS
powered by light+building



3025

Warmth, in your place

55x55, 4 Controls, different Materials. Integrated thermostat detecting and regulating a desired temperature. Materials, functionalities, finishing are essential values for your environment project.



eelecta

You, in an homy and environmental world

A product range dedicated to democratic, smart and creative design.

To the interaction between users and lighting control, energy saving, temperature control, entertainment.

DESIGN PLUS
powered by light+building



reddot design award
winner 2012

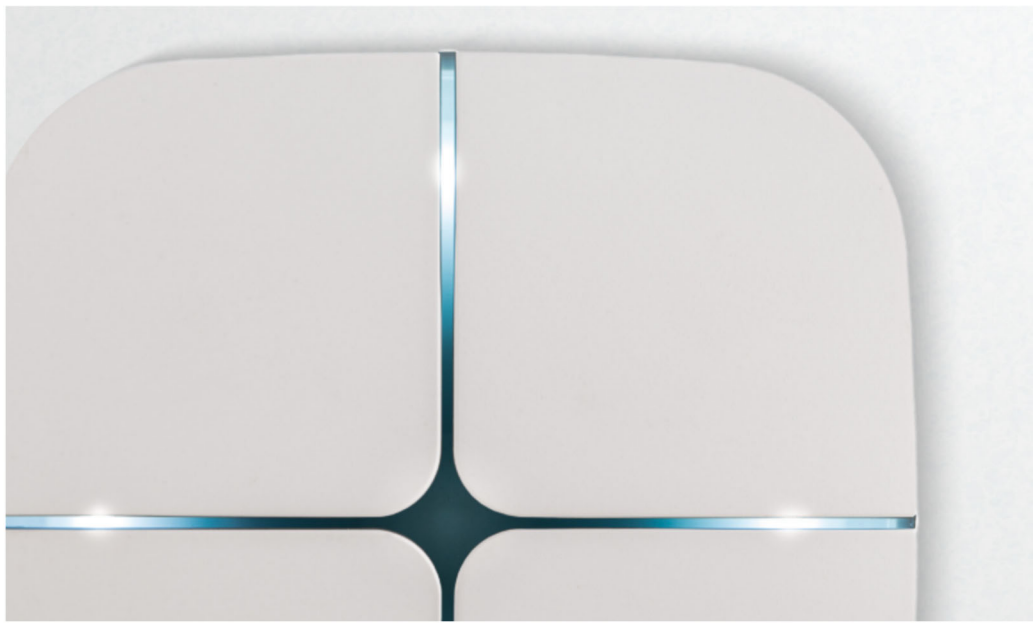

KNX Capacitive Switch

The KNX® 9025 switch range consists of 4 – 8 – 10 channels capacitive buttons. Each button can be configured to manage on/off commands, dimming, shutters and venetians control, scene recall and control, objects sequences etc;

Device includes a 2 stage Room Temperature Controller with integrated PI to control heating and cooling equipments, valves, 2 and 4 pipes fan coils; etc. Device has an embedded temperature sensor and a rear 2 poles connector configurable as digital or analog input; It's possible to connect an additional NTC temperature probe (eelectron codes TS01A01ACC - TS01B01ACC - TS01D01ACC not included) to perform a direct temperature measurement.

9025 range has a RGB led bar on the front side in order to visualize feedbacks or other values available over the KNX bus (function available on the RGB range). Devices are available in 2 ranges: RGB LINE and RGB double glass; each range may have glasses in CUSTOM version. Using glasses in CUSTOM version is possible to light up custom and interchangeable icons matching with the associated function. The 9025 KNX® range is mounted in 2 module box and is compliant with main standards (British, German, Italian, etc).

Device is equipped with KNX communication interface.

2 Modules Version

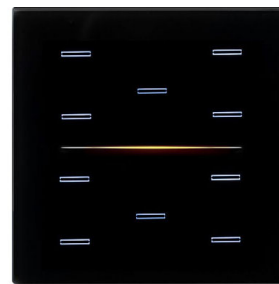

Order Codes

KNX Capacitive Switch Boards

CS10A01KNX-1

KNX Capacitive switch - White

CS10A01KNX-3

KNX Capacitive switch - Black

RGB Line Series Covers

9025GL04L01

Single glass 4 ch. - White

9025GL08L01

Single glass 8 ch. - White

9025GL10L01

Single glass 10 ch. - White

9025GL04L03

Single glass 4 ch. - Black

9025GL08L03

Single glass 8 ch. - Black

9025GL10L03

Single glass 10 ch. - Black

RGB Range Covers

9025GL04B01

Double Glass 4 channels - White

9025GL08B01

Double Glass 8 channels - White

9025GL10B01

Double Glass 10 channels - White

9025GL04B03

Double Glass 4 channels - Black

9025GL08B03

Double Glass 8 channels - Black

9025GL10B03

Double Glass 10 channels - Black

Line Series & RGB Range Covers – Custom

9025GL10D01

CUSTOM double glass - White

9025GL10D03

CUSTOM double glass - Black

9025GL10W01

CUSTOM single glass - White

9025GL10W03

CUSTOM single glass - Black

Technical Features

Mechanical data	<ul style="list-style-type: none"> Dimensions: (W x H x D) 96 x 96 x 36 mm
Mounting	<ul style="list-style-type: none"> British box, German box or Italian 2 modules box
Supply	<ul style="list-style-type: none"> Via bus EIB/KNX cable: 21 ÷ 32 Vdc
Rear Input - digital mode	<ul style="list-style-type: none"> For free potential contacts (dry contacts) Max. length of Connecting Cables ≤ 10 m (twisted cable)
Rear input - analog mode for temperature probe	<p>For NTC temperature probe eelectron code:</p> <ul style="list-style-type: none"> TS01A01ACC (range from -20°C to +100°C) TS01B01ACC (range from -50°C to +60°C) TS01D01ACC (range from -40°C to 125°C) Max. length of Connecting Cable: ≤ 20 m (twisted cable)

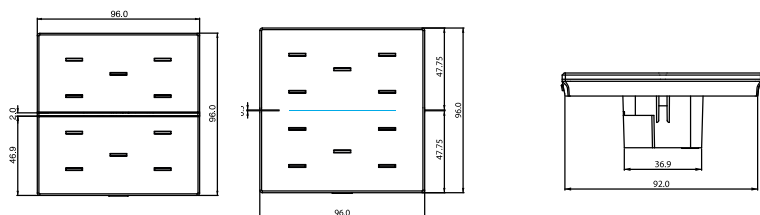

RGB RANGE

LINE SERIES

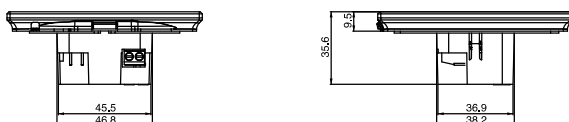

2 Modules Version

KNX Capacitive Switch Boards



CS10A01KNX-1
Capacitive switch KNX - White



CS10A01KNX-3
Capacitive switch KNX - Black

RGB Line Series Covers



9025GL04L01
Single glass 4 ch. - White



9025GL08L01
Single glass 8 ch. - White



9025GL10L01
Single glass 10 ch. - White

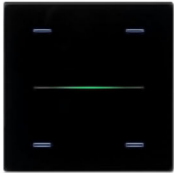

9025GL04L03
Single glass 4 ch. - Black



9025GL08L03
Single glass 8 ch. - Black

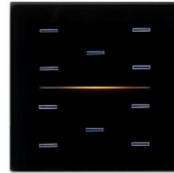

9025GL10L03
Single glass 10 ch. - Black

RGB Double Glass Range Covers



9025GL04B01
Double glass 4 ch. - White



9025GL08B01
Double glass 8 ch. - White

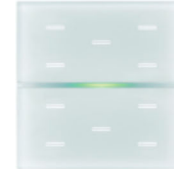

9025GL10B01
Double glass 10 ch. - White

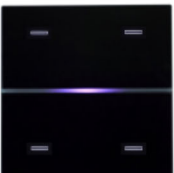

9025GL04B03
Double glass 4 ch. - Black

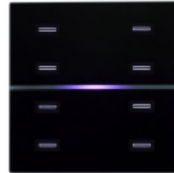

9025GL08B03
Double glass 8 ch. - Black

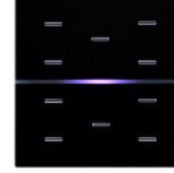

9025GL10B03
Double glass 10 ch. - Black

Line Series & Double Glass Range Covers — CUSTOM



9025GL10D01
CUSTOM double glass - White



9025GL10D03
CUSTOM double glass - Black

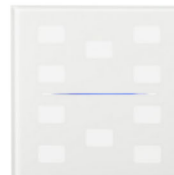

9025GL10W01
CUSTOM single glass - White



9025GL10W03
CUSTOM single glass - Black

CUSTOM version covers have to be associated with dedicated interchangeable icons sheets.

KNX Capacitive Switch

The KNX® 9025 switch range consists of 4 - 8 - 10 channels capacitive buttons. Each button can be configured to manage on/off commands, dimming, shutters and venetians control, scene recall and control, objects sequences etc;

Device includes a 2 stage Room Temperature Controller with integrated PI to control heating and cooling equipments, valves, 2 and 4 pipes fan coils; etc. Device has an embedded temperature sensor and a rear 2 poles connector configurable as digital or analog input; It's possible to connect an additional NTC temperature probe (eelectron codes TS01A01ACC - TS01B01ACC - TS01D01ACC not included) to perform a direct temperature measurement.

9025 range has a RGB led bar on the front side in order to visualize feedbacks or other values available over the KNX bus (function available on the RGB range). Devices are available in 2 ranges: RGB LINE and RGB double glass; each range may have glasses in CUSTOM version. Using glasses in CUSTOM version is possible to light up custom and interchangeable icons matching with the associated function. The 9025 KNX® range is mounted in 3 module box and is compliant with main standards (British, German, Italian, etc).

Device is equipped with KNX communication interface.

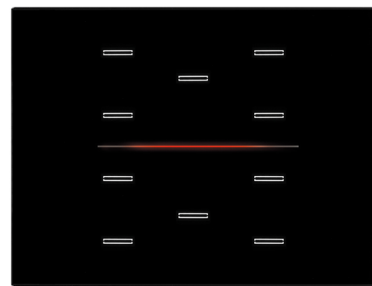

Order Codes

KNX Capacitive Switch Boards

CS10A01KNX-1-3M

KNX Capacitive switch - 3 Modules - White

CS10A01KNX-3-3M

KNX Capacitive switch - 3 Modules - Black

RGB Line Series Covers

9025GL304L01

Glass 4 channels - 3 Modules - White

9025GL308L01

Glass 8 channels - 3 Modules - White

9025GL310L01

Glass 10 channels - 3 Modules - White

9025GL304L03

Glass 4 channels - 3 Modules - Black

9025GL308L03

Glass 8 channels - 3 Modules - Black

9025GL310L03

Glass 10 channels - 3 Modules - Black

RGB Line Series Covers — Custom

9025GL310W01

Custom glass - 3 Modules - White

9025GL310W03

Custom glass - 3 Modules - Black

Technical Features

Mechanical data	<ul style="list-style-type: none"> Dimensions: (W x H x D) 96 x 126 x 36 mm
Mounting	<ul style="list-style-type: none"> British box, German box or Italian 2/3 modules box
Supply	<ul style="list-style-type: none"> Via bus EIB/KNX cable: 21 ÷ 32 Vdc
Rear Input - digital mode	<ul style="list-style-type: none"> For free potential contacts (dry contacts) Max. length of Connecting Cables ≤ 10 m (twisted cable)
Rear input - analog mode for temperature probe	<p>For NTC temperature probe eelectron code:</p> <ul style="list-style-type: none"> TS01A01ACC (range from -20°C to +100°C) TS01B01ACC (range from -50°C to +60°C) TS01D01ACC (range from -40°C to 125°C) Max. length of Connecting Cable: ≤ 20 m (twisted cable)

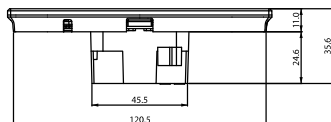
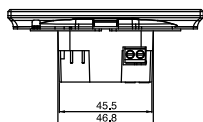
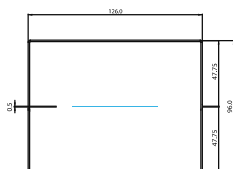

3 Modules Version

KNX Capacitive Switch Boards



CS10A01KNX-1 - 3M
Capacitive switch KNX - White



CS10A01KNX-3 - 3M
Capacitive switch KNX - Black

RGB Line Series Covers



9025GL304L01
Glass 4 ch. - 3 Modules - White



9025GL308L01
Glass 8 ch. - 3 Modules - White



9025GL310L01
Glass 10 ch. - 3 Modules - White



9025GL304L03
Glass 4 ch. - 3 Modules - Black



9025GL308L03
Glass 8 ch. - 3 Modules - Black



9025GL310L03
Glass 10 ch. - 3 Modules - Black

RGB Line Series Covers — CUSTOM



9025GL310D01
CUSTOM glass - 3 Modules
White

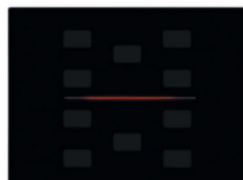

9025GL310D03
CUSTOM glass - 3 Modules
Black

CUSTOM version covers have to be associated with dedicated interchangeable icons sheets.

KNX Thermostat / Humidistat

The 9025 thermostat is a KNX® room temperature controller that includes 7 Order Codes configurable capacitive buttons for on / off, dimming, rolling shutters and venetian controls, scene recall and control, object sequences, local thermostat controls, etc.

Device offers a 2 stage thermostat with integrated PI controller to control heating and cooling equipments, valves, 2 and 4 pipes fan coils etc ..

Device has an embedded temperature sensor and a rear 2 poles connector, configurable as digital or analog input; It's possible to connect an additional NTC temperature probe (electron codes TS01A01ACC - TS01B01ACC - TS01D01ACC not included) to perform a direct temperature measurement. A version with integrated temperature and relative humidity sensor is available usable for controlling actuators for ambient humidity control.

9025 range has a RGB led bar on the front side in order to visualize thermostat operating modes or feedbacks and other values available over the KNX bus. The device includes an RGB led bar on the front to display status or other values available on the KNX bus. Glass covers are available for HOTEL or RESIDENTIAL applications; both covers can be in CUSTOM version. Using glasses in CUSTOM version is possible to light up custom and interchangeable icons matching with the associated function.

The 9025 KNX® range is mounted in 2 module box and is compliant with main standards (British, German, Italian, etc).

Device is equipped with KNX communication interface.



Order Codes

KNX Thermostat/Humidistat Boards

RT07A01KNX-1

KNX Capacitive Thermostat - White

RH07A01KNX-1

KNX Capacitive Thermostat/Humidistat White

RT07A01KNX-3

KNX Capacitive Thermostat - Black

RH07A01KNX-3

KNX Capacitive Thermostat/Humidistat Black

Thermostat/Humidistat Covers

9025GT07L01-R

Single glass - RESIDENTIAL display White

9025GT07L01-H

Single glass - HOTEL display White

9025GT07L03-R

Single glass - RESIDENTIAL display Black

9025GT07L03-H

Single glass - HOTEL display Black

Custom version Cover

9025GT07W01-R

CUSTOM single glass RESIDENTIAL White

9025GT07W03-R

CUSTOM single glass RESIDENTIAL Black

9025GT07W01-H

CUSTOM single glass HOTEL - White

9025GT07W03-H

CUSTOM single glass HOTEL - Black

Technical Features

Mechanical data	<ul style="list-style-type: none"> Dimensions: (W x H x D) 96 x 96 x 36 mm
Mounting	<ul style="list-style-type: none"> British box, German box or Italian 2 modules box
Supply	<ul style="list-style-type: none"> Via bus EIB/KNX cable: 21 ÷ 32 Vdc
Rear Input - digital mode	<ul style="list-style-type: none"> For free potential contacts (dry contacts) Max. length of Connecting Cables ≤ 10 m (twisted cable)
Rear input - analog mode for temperature probe	<p>For NTC temperature probe electron code:</p> <ul style="list-style-type: none"> TS01A01ACC (range from -20°C to +100°C) TS01B01ACC (range from -50°C to +60°C) TS01D01ACC (range from -40°C to 125°C) Max. length of Connecting Cable: ≤ 20 m (twisted cable)

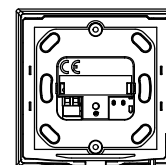
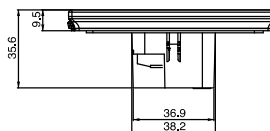
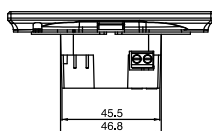
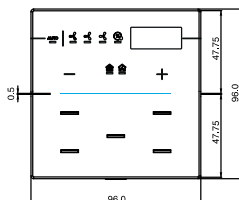
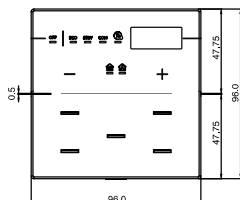

2 Modules Version

KNX Capacitive Thermostat Boards



RT07A01KNX-1
KNX capacitive thermostat
White



RH07A01KNX-1
KNX capacitive thermostat/humidistat
White



RT07A01KNX-3
KNX capacitive thermostat
Black



RH07A01KNX-3
KNX capacitive thermostat/humidistat
Black

Thermostat/Humidistat RGB Line Series Covers



9025GT07L01-R
Single Glass
RESIDENTIAL display - White



9025GT07L01-H
Single Glass
HOTEL display - White



9025GT07L03-R
Single Glass
RESIDENTIAL display - Black



9025GT07L03-H
Single Glass
HOTEL display - White

Custom Version — **Residential RGB Line Series**



9025GT07W01-R
Single CUSTOM Glass
RESIDENTIAL display - White



9025GT07W03-R
Single CUSTOM Glass
RESIDENTIAL display - Black

Custom Version — **Hotel RGB Line Series**



9025GT07W01-H
Single CUSTOM Glass
HOTEL display - White



9025GT07W03-H
Single CUSTOM Glass
HOTEL display - Black

KNX Thermostat / Humidistat

The 9025 thermostat is a KNX® room temperature controller that includes 7 Order Codes configurable capacitive buttons for on / off, dimming, rolling shutters and venetian controls, scene recall and control, object sequences, local thermostat controls, etc.

Device offers a 2 stage thermostat with integrated PI controller to control heating and cooling equipments, valves, 2 and 4 pipes fan coils etc ..

Device has an embedded temperature sensor and a rear 2 poles connector, configurable as digital or analog input; It's possible to connect an additional NTC temperature probe (electron codes TS01A01ACC or TS01B01ACC - not included) to perform a direct temperature measurement.

A version with integrated temperature and relative humidity sensor is available usable for controlling actuators for ambient humidity control.

9025 range has a RGB led bar on the front side in order to visualize thermostat operating modes or feedbacks and other values available over the KNX bus. The device includes an RGB led bar on the front to display status or other values available on the KNX bus. Glass covers are available for HOTEL or RESIDENTIAL applications; both covers can be in CUSTOM version. Using glasses in CUSTOM version is possible to light up custom and interchangeable icons matching with the associated function.

The 9025 KNX® range is mounted in 2 module box and is compliant with main standards (British, German, Italian, etc).

Device is equipped with KNX communication interface.



Order Codes

KNX Thermostat/Humidistat Boards

RT07A01KNX-1-3M

KNX Capacitive Thermostat - 3 Modules White

RH07A01KNX-1-3M

KNX Capacitive Thermostat/Humidistat 3 Modules - White

RT07A01KNX-3-3M

KNX Capacitive Thermostat - 3 Modules Black

RH07A01KNX-3-3M

KNX Capacitive Thermostat/Humidistat 3 Modules - Black

Thermostat/Humidistat RGB Line Series Covers

9025GT307L01-R

Single glass RESIDENTIAL display - 3 Modules - White

9025GT307L01-H

Single glass HOTEL display - 3 Modules White

9025GT307L03-R

Single glass RESIDENTIAL display - 3 Modules - Black

9025GT307L03-H

Single glass HOTEL display - 3 Modules Black

Custom Version | RGB Line Series

9025GT307W01-R

CUSTOM single glass RESIDENTIAL - 3 Modules - White

9025GT307W03-R

CUSTOM single glass RESIDENTIAL - 3 Modules - Black

9025GT307W01-H

CUSTOM single glass HOTEL - 3 Modules White

9025GT307W03-H

CUSTOM single glass HOTEL - 3 Modules Black

Technical Features

Mechanical data	<ul style="list-style-type: none"> • Dimensions: (W x H x D) 96 x 96 x 36 mm
Mounting	<ul style="list-style-type: none"> • British box, German box or Italian 2 modules box
Supply	<ul style="list-style-type: none"> • Via bus EIB/KNX cable: 21 ÷ 32 Vdc
Rear Input - digital mode	<ul style="list-style-type: none"> • For free potential contacts (dry contacts) • Max. length of Connecting Cables ≤ 10 m (twisted cable)
Rear input - analog mode for temperature probe	<p>For NTC temperature probe electron code:</p> <ul style="list-style-type: none"> • TS01A01ACC (range from -20°C to +100°C) • TS01B01ACC (range from -50°C to +60°C) • TS01D01ACC (range from -40°C to 125°C) • Max. length of Connecting Cable: ≤ 20 m (twisted cable)

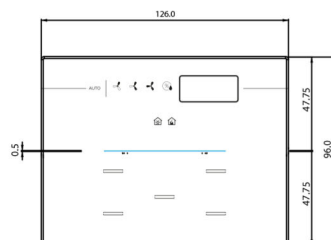

3 Modules Version

KNX Capacitive Thermostat Boards



RT07A01KNX-1-3M
KNX capacitive thermostat - White



RH07A01KNX-1-3M
KNX capacitive thermostat/humidistat - White



RT07A01KNX-3-3M
KNX capacitive thermostat - Black



RH07A01KNX-3-3M
KNX capacitive thermostat/humidistat - Black

Thermostat/Humidistat RGB Line Series Covers



9025GT307L01-R
Single Glass
RESIDENTIAL display - White



9025GT307L01-H
Single Glass
HOTEL display - White



9025GT307L03-R
Single Glass
RESIDENTIAL display - Black



9025GT307L03-H
Single Glass
HOTEL display - Black

Custom Version — Residential | RGB Line Series



9025GT307W01-R
CUSTOM Single Glass
RESIDENTIAL display - White



9025GT307W03-R
CUSTOM Single Glass
RESIDENTIAL display - Black

Custom Version — Hotel | RGB Line Series



9025GT307W01-H
CUSTOM Single Glass
HOTEL display - White



9025GT307W03-H
CUSTOM Single Glass
HOTEL display - Black

KNX Thermostat / Humidistat



RT07A01KNX-1
KNX capacitive thermostat
White



RH07A01KNX-1
KNX capacitive thermostat/humidistat
White



RT07A01KNX-3
KNX capacitive thermostat
Black



RH07A01KNX-3
KNX capacitive thermostat/humidistat
Black



Order Codes

Thermostat/Humidistat KNX

RT07A01KNX-1

KNX Capacitive Thermostat - White

RH07A01KNX-1

KNX Capacitive Thermostat/Humidistat
White

RT07A01KNX-3

KNX Capacitive Thermostat - Black

RH07A01KNX-3

KNX Capacitive Thermostat/Humidistat
Black

Thermostat/Humidistat Covers

9025GT07B01R

Double glass RESIDENTIAL display - White

9025GT07B01H

Double glass HOTEL display - White

9025GT07B03R

Double glass RESIDENTIAL display - Black

9025GT07B03H

Double glass HOTEL display - Black

Custom Version Covers

9025GT07D01R

CUSTOM Double glass RESIDENTIAL
display - White

9025GT07D03R

CUSTOM Double glass RESIDENTIAL
display - Black

9025GT07D01H

CUSTOM Double glass HOTEL display -
White

9025GT07D03H

CUSTOM Double glass HOTEL display -
Black

Thermostat/Humidistat Covers



9025GT07B01-R
Double glass
RESIDENTIAL display
White



9025GT07B01-H
Double glass
HOTEL display
White



9025GT07B03-R
Double glass
RESIDENTIAL display
Black



9025GT07B03-H
Double glass
HOTEL display
Black

Custom Version — Residential



9025GT07D01-R
CUSTOM double glass
RESIDENTIAL display
White



9025GT07D03-R
CUSTOM double glass
RESIDENTIAL display
Black

Custom Version — Hotel



9025GT07D01-H
CUSTOM double glass
HOTEL display
White



9025GT07D03-H
CUSTOM double glass
HOTEL display
Black

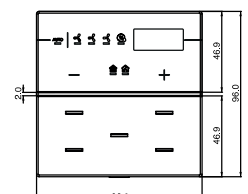
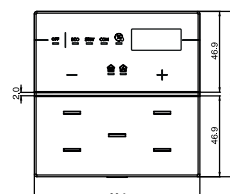

Icons Sheet Sets

Order Codes

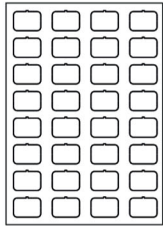

9025ISA-1

icon sheet
SET A | White
32 icons



9025ISB-1

icon sheet
SET B | White
32 icons



9025ISC-1

icon sheet
SET C | White
32 icons



9025ISD-1

icon sheet
SET D | White
32 icons

9025ISA-1
Icon sheet SET A - 32 icons - White

9025ISB-1
Icon sheet SET B - 32 icons - White

9025ISC-1
Icon sheet SET C - 32 icons - White

9025ISD-1
Icon sheet SET D - 32 icons - White

9025ISE-1
Icon sheet SET E - 32 icons - White

9025ISF-1
Icon sheet SET F - 32 icons - White

9025ISH-1
Icon sheet SET H - 32 icons - White

9025ISA-3
Icon sheet SET A - 32 icons - Black

9025ISB-3
Icon sheet SET B - 32 icons - Black

9025ISC-3
Icon sheet SET C - 32 icons - Black

9025ISD-3
Icon sheet SET D - 32 icons - Black

9025ISE-3
Icon sheet SET E - 32 icons - Black

9025ISF-3
Icon sheet SET F - 32 icons - Black

9025ISH-3
Icon sheet SET H - 32 icons - Black

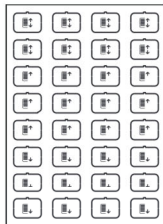

9025ISE-1

icon sheet
SET E | White
32 icons

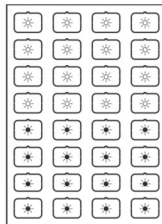

9025ISF-1

icon sheet
SET F | White
32 icons



9025ISH-1

icon sheet
SET H | White
32 icons

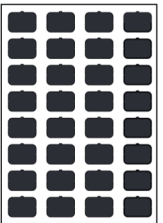

9025ISA-3

icon sheet
SET A | Black
32 icons



9025ISB-3

icon sheet
SET B | Black
32 icons



9025ISC-3

icon sheet
SET C | Black
32 icons



9025ISD-3

icon sheet
SET D | Black
32 icons



9025ISE-3

icon sheet
SET E | Black
32 icons



9025ISF-3

icon sheet
SET F | Black
32 icons



9025ISH-3

icon sheet
SET H | Black
32 icons

9025 Multisensor Controller

HUMIDITY - TEMPERATURE

The environmental sensor HC06A01KNX is a device of the 9025 series, it is wall-mounted and finished with a white or black glass.

The HC06A01KNX device integrates humidity and temperature sensors. The device is also equipped with a 2-way connector on the rear side that can be configured as a digital or analogue input; in fact it is possible to connect an additional NTC probe to the device (eelectron code TS01A01ACC - TS01B01ACC - TS01D01ACC not included) to obtain a second temperature measurement.

The device includes 2 double-stage thermostats for controlling two distinct areas, both with an integrated PI controller for driving heating and cooling equipment, valves, 6-way valves, 2 and 4-pipe fan coils, etc ...

The humidity sensor manages the reading of the relative humidity in the environment and allows threshold control with hysteresis of humidification and dehumidification equipments.

The device embeds 6 capacitive keys for the management of on / off commands, dimmers, shutters and blinds, execution and learning of scenarios, object sequences, local thermostat controls, etc.

It includes a RGB LED on the front side for displaying states (temperature, humidity and CO₂) or other quantities available on the KNX bus.

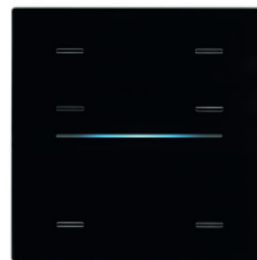

9025GH06 L01
Single glass line 6 ch. - White

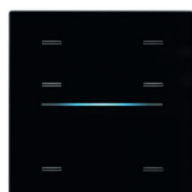

9025GH06 L03
Single glass line 6 ch. - Black

Order Codes

KNX Capacitive Switch Boards

HC06A01KNX-3

Humidity Sensor + Thermostat - Inwall - No Display - White

HC06A01KNX-1

Humidity Sensor + Thermostat - Inwall - No Display - Black

RGB Range Covers

9025GH06L01

Single glass line 6 ch. - White

9025GH06L03

Single glass line 6 ch. - Black

Technical Features

Mechanical data	<ul style="list-style-type: none"> • Dimensions: (W x H x D) 96 x 96 x 36 mm
Mounting	<ul style="list-style-type: none"> • British box, German box or Italian 2 modules box
Supply	<ul style="list-style-type: none"> • Via bus EIB/KNX cable: 21 ÷ 32 Vdc
Rear Input - digital mode	<ul style="list-style-type: none"> • For free potential contacts (dry contacts) • Max. length of Connecting Cables ≤ 10 m (twisted cable) • Voltage Scanning 3,3 Vdc (internally generated)
Rear input - analog mode for temperature probe	<p>For NTC temperature probe eelectron code:</p> <ul style="list-style-type: none"> • TS01A01ACC (range from -20°C to +100°C) • TS01B01ACC (range from -50°C to +60°C) • TS01D01ACC (range from -40°C to 125°C) • Max. length of Connecting Cable: ≤ 20 m (twisted cable)

9025 Multisensor Controller

CO₂ - HUMIDITY - TEMPERATURE

The environmental sensor MC06A01KNX is a device of the 9025 series, it is wall-mounted and finished with a white or black glass.

In the MC06A01KNX device there are 3 sensors available: temperature, humidity and CO₂, this measure is detected by using an integrated probe specially designed to detect CO₂ data directly and not through calculations based on other sensors.

The device is also equipped with a 2-way connector on the rear side that can be configured as a digital or analogue input; in fact it is possible to connect an additional NTC probe to the device (eelectron code TS01A01ACC - TS01B01ACC - TS01D01ACC not included) to obtain a second temperature measurement.

The device includes 2 double-stage thermostats for controlling two distinct areas, both with an integrated PI controller for driving heating and cooling equipment, valves, 6-way valves, 2 and 4-pipe fan coils, etc ...

The humidity sensor manages the reading of the relative humidity in the environment and allows threshold control with hysteresis of humidification and dehumidification equipments.

The device embeds 6 capacitive keys for the management of on / off commands, dimmers, shutters and blinds, execution and learning of scenarios, object sequences, local thermostat controls, etc.

It includes a RGB LED on the front side for displaying states (temperature, humidity and CO₂) or other quantities available on the KNX bus.



Order Codes

KNX Capacitive Switch Boards

MC06A01KNX-1

Multisensor CO₂ + Humidity + Temperature
- Inwall - No Display - White

MC06A01KNX-3

Multisensor CO₂ + Humidity + Temperature
- Inwall - No Display - Black

RGB Range Covers

9025GM06L01

Single glass line 6 ch. - White

9025GM06L03

Single glass line 6 ch. - Black

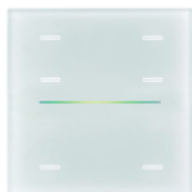

9025GM06L01

Single glass line 6 ch. - White



9025GM06L03

Single glass line 6 ch. - Black

Technical Features

Mechanical data	<ul style="list-style-type: none"> • Dimensions: (W x H x D) 96 x 96 x 40 mm
Mounting	<ul style="list-style-type: none"> • British box, German box or Italian 2 modules box
Supply	<ul style="list-style-type: none"> • Via bus EIB/KNX cable: 21 ÷ 32 Vdc
Rear Input - digital mode	<ul style="list-style-type: none"> • For free potential contacts (dry contacts) • Max. length of Connecting Cables ≤ 10 m (twisted cable) • Voltage Scanning 3,3 Vdc (internally generated)
Rear input - analog mode for temperature probe	<p>For NTC temperature probe eelectron code:</p> <ul style="list-style-type: none"> • TS01A01ACC (range from -20°C to +100°C) • TS01B01ACC (range from -50°C to +60°C) • TS01D01ACC (range from -40°C to 125°C) • Max. length of Connecting Cable: ≤ 20 m (twisted cable)

9025 Temperature Probe

The device TS01D01ACC of the 9025 series is a temperature probe connectible to KNX® devices.

The device is used in combination with the glass covers available in white (electron code 9025GS00A01) or black (electron code 9025GS00A03) variants;

The device is mounted in 2 or 3 module box and is compliant with main standards (British, German, Italian, etc).



Technical Features

Mechanical data	<ul style="list-style-type: none"> Dimensions: (W x H x D) 96 x 96 x 36 mm
Rear input - analog mode for temperature probe	<p>For NTC temperature probe electron code:</p> <ul style="list-style-type: none"> TS01A01ACC (range from -20°C to +100°C) TS01B01ACC (range from -50°C to +60°C) TS01D01ACC (range from -40°C to 125°C) Max. length of Connecting Cable: ≤ 30 m (twisted cable)
Environmental Specification	<ul style="list-style-type: none"> Operating temperature: -5 °C + 45 °C Storage temperature: - 20 °C + 55 °C

Order Codes

TS01D01ACC-1 Temperature probe - White
TS01D01ACC-3 Temperature probe - Black
TS01D01ACC-1-3M Temperature probe - 3 Modules - White
TS01D01ACC-3-3M Temperature probe - 3 Modules - Black
9025GS00A01 Single glass - White
9025GS00A03 Single glass - Black
9025GS300A01 Single glass - 3 Modules - White
9025GS300A03 Single glass - 3 Modules - Black

KNX Capacitive Switch Boards

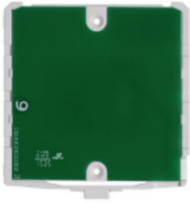

TS01D01ACC-1
Temperature probe - White



TS01D01ACC-3
Temperature probe - Black

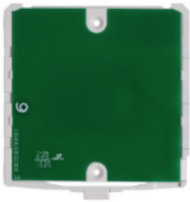

TS01D01ACC-1-3M
Temperature probe - 3 Modules - White



TS01D01ACC-3-3M
Temperature probe - 3 Modules - Black

Single Glass Covers



9025GS00A01
Single glass - White



9025GS00A03
Single glass - Black



9025GS300A01
Single glass - 3 Modules - White



9025GS300A03
Single glass - 3 Modules - Black

9025 Frames

Design frames and supports are available in 9025 glossy finish. A complement created to harmonize the aesthetics of electrical sockets and fruit holders as well. Available in PMMA and adapt with the most common European standard inwall boxes in 2, 3 and 4 modules formats.

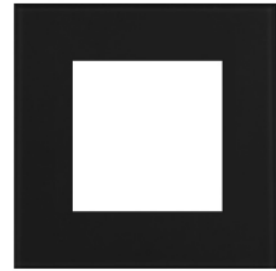

*Compatible with 4Box®, Vitrum Design®, Biticino Living light®, Vimar Plana®, Vimar Arké® sockets.

Order Codes

AJ.19.L.02

Support For 2 Modules Cover Frame (Pack Of 10 pcs.)*

AJ.19.L.03

Support For 3 Modules Cover Frame (Pack Of 10 pcs.)*

AJ.19.L.04

Support For 4 Modules Cover Frame (Pack Of 10 pcs.)*

EEBP200790001-3

Design Frame - Black Lucid - 2 Modules - Pmma (Pack Of 10 pcs.)*

EEBP200790000-1

Design Frame - White - 2 Modules - Pmma (Pack Of 10 pcs.)*

EEEP300790001-3

Design Frame - Black Lucid - 3 Modules - Pmma (Pack Of 10 pcs.)*

EEEP300790000-1

Design Frame - White - 3 Modules - Pmma (Pack Of 10 pcs.)*

EEQP400790001-3

Design Frame - Black Lucid - 4 Modules - Pmma (Pack Of 10 pcs.)*

EEQP400790000-1

Design Frame - White - 4 Modules - Pmma (Pack Of 10 pcs.)*



AJ.19.L.02
Support For 2 Modules Cover Frame

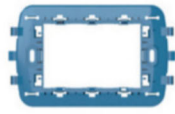

AJ.19.L.03
Support For 3 Modules Cover Frame



AJ.19.L.04
Support For 4 Modules Cover Frame



EEBP200790001-3
Design Frame - Black Lucid - 2 Modules



EEBP200790000-1
Design Frame - White - 2 Modules



EEEP300790001-3
Design Frame - Black Lucid - 3 Modules



EEEP300790000-1
Design Frame - White - 3 Modules



EEQP400790001-3
Design Frame - Black Lucid - 4 Modules



EEQP400790000-1
Design Frame - White - 4 Modules

9025 Access Control

KNX TRANSPONDER READER

The 9025 series devices dedicated to access control management are KNX® devices and use RFID - MIFARE® technology. The range includes: TR00C01KNX: Doorpanel transponder reader, TH00C01KNX: Transponder holder, TE00C01KNX: Transponder card programmer

The products are intended to be installed with the glass covers which can be customized on request.

The upper part of the glass is backlit (to illuminate the room number or a logo - both customizations on request); in the lower part there are 3 freely configurable backlit capacitive buttons.

For TR00C01KNX: 1 button (typically with bell function) and 2 LEDs for displaying the MUR and DND states.

The transponder is read by placing it in front of the reader, at a maximum distance of 30 mm. The color of the reader RGB LED bar indicates that the card has been recognized and shows different (configurable) colors for status or anomalies reporting, such as:

- Card recognized (welcome): default color Green
- Incorrect system code: color default Orange
- Unrecognized ID card: default color Red
- Wrong Card Date (validity expired): default color Yellow
- Wrong time of day (Entry forbidden time): default color Magenta
- Wrong day of the week (Entry prohibited day): default color Blue-Cyan

The reader also integrates a buzzer (which can be activated with the ETS parameter) for anomalies signaling.

The 9025 KNX® range is mounted in 2 modules box and is compliant with main standards (British, German, Italian, etc). Device is equipped with KNX communication interface.

2 Modules Version



Order Codes

KNX Transponder Reader

TR00C01KNX-1

Transponder Reader with 3 control buttons
White

TR00C01KNX-3

Transponder Reader with 3 control buttons
Black

Transponder Reader RGB Line Series Covers

9025PTR03L01

Single plexiglass - White

9025PTR03L03

Single plexiglass - Black

9025GTR03L01

Single glass - White

9025GTR03L03

Single glass - Black

Technical Features

Mechanical data	<ul style="list-style-type: none"> • Dimensions: (W x H x D) 96 x 96 x 36 mm
Mounting	<ul style="list-style-type: none"> • British box, German box or Italian 2 modules box
Supply	<ul style="list-style-type: none"> • Via bus EIB/KNX cable: 21 ÷ 32 Vdc • Auxiliary supply: 12 ÷ 24 Vdc / ac
Rear Input - digital mode	<ul style="list-style-type: none"> • For free potential contacts (dry contacts) • Max. length of Connecting Cables ≤ 10 m (twisted cable)
Rear input - analog mode for temperature probe	<p>For NTC temperature probe eelectron code:</p> <ul style="list-style-type: none"> • TS01A01ACC (range from -20°C to +100°C) • TS01B01ACC (range from -50°C to +60°C) • TS01D01ACC (range from -40°C to 125°C) • Max. length of Connecting Cable: ≤ 30 m (twisted cable)

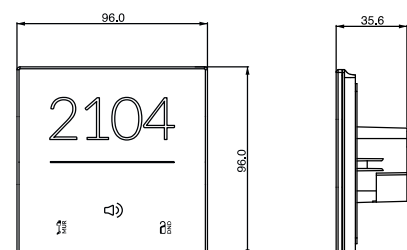

2 Modules Version

KNX Transponder Reader



TR00C01KNX-1
Transponder Reader with
3 control buttons - White



TR00C01KNX-3
Transponder Reader
with 3 control buttons - Black

Transponder Reader Covers | RGB Line Series



9025PTR03L01
Single plexiglass - White



9025PTR03L03
Single plexiglass - Black



9025GTR03L01
Single glass - White



9025GTR03L03
Single glass - Black

9025 Access Control

KNX TRANSPONDER READER

The 9025 series devices dedicated to access control management are KNX® devices and use RFID - MIFARE® technology. The range includes: TR00C01KNX: Doorpanel transponder reader, TH00C01KNX: Transponder holder, TE00C01KNX: Transponder card programmer

The products are intended to be installed with the glass covers which can be customized on request.

The upper part of the glass is backlit (to illuminate the room number or a logo - both customizations on request); in the lower part there are 3 freely configurable backlit capacitive buttons.

For TR00C01KNX: 1 button (typically with bell function) and 2 LEDs for displaying the MUR and DND states.

The transponder is read by placing it in front of the reader, at a maximum distance of 30 mm. The color of the reader RGB LED bar indicates that the card has been recognized and shows different (configurable) colors for status or anomalies reporting, such as:

- Card recognized (welcome): default color Green
- Incorrect system code: color default Orange
- Unrecognized ID card: default color Red
- Wrong Card Date (validity expired): default color Yellow
- Wrong time of day (Entry forbidden time): default color Magenta
- Wrong day of the week (Entry prohibited day): default color Blue-Cyan

The reader also integrates a buzzer (which can be activated with the ETS parameter) for anomalies signaling.

The 9025 KNX® range is mounted in 3 modules box and is compliant with main standards (British, German, Italian, etc). Device is equipped with KNX communication interface.



Order Codes

KNX Transponder Reader

TR00C01KNX-1-3M

Transponder Reader with 3 control buttons
3 Modules - White

TR00C01KNX-3-3M

Transponder Reader with 3 control buttons
3 Modules - Black

Transponder Reader RGB Line Series Covers

9025PTR303L01

Single plexiglass - 3 Modules - White

9025PTR303L03

Single plexiglass - 3 Modules - Black

9025GTR303L01

Single glass - 3 Modules - White

9025GTR303L03

Single glass - 3 Modules - Black

Technical Features

Mechanical data	<ul style="list-style-type: none"> • Dimensions: (W x H x D) 126 x 96 x 36 mm
Mounting	<ul style="list-style-type: none"> • British box, German box or Italian 2 or 3 modules box
Supply	<ul style="list-style-type: none"> • Via bus EIB/KNX cable: 21 ÷ 32 Vdc • Auxiliary supply: 12 ÷ 24 Vdc / ac
Rear Input - digital mode	<ul style="list-style-type: none"> • For free potential contacts (dry contacts) • Max. length of Connecting Cables ≤ 10 m (twisted cable)
Rear input - analog mode for temperature probe	<p>For NTC temperature probe eelectron code:</p> <ul style="list-style-type: none"> • TS01A01ACC (range from -20°C to +100°C) • TS01B01ACC (range from -50°C to +60°C) • TS01D01ACC (range from -40°C to 125°C) • Max. length of Connecting Cable: ≤ 30 m (twisted cable)

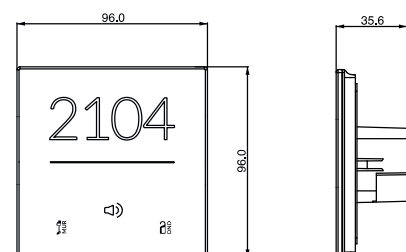

3 Modules Version

KNX Transponder Reader



TR00C01KNX-1-3M
Transponder Reader with 3 control buttons 3 Modules - White



TR00C01KNX-3-3M
Transponder Reader with 3 control buttons 3 Modules - Black

Transponder Reader Covers | RGB Line Series



9025PTR303L01
Single plexiglass - 3 Modules - White



9025PTR303L03
Single plexiglass - 3 Modules - Black



9025GTR303L01
Single glass - 3 Modules - White

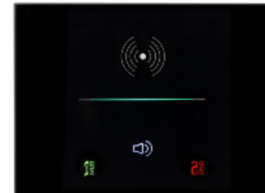

9025GTR303L03
Single glass - 3 Modules - Black

9025 Access Control

KNX TRANSPONDER HOLDER

The 9025 series devices dedicated to access control management are KNX® devices and use RFID - MIFARE® technology. The range includes: TR00C01KNX: Doorpanel transponder reader, TH00C01KNX: Transponder holder, TE00C01KNX: Transponder card programmer.

The products are intended to be installed with the glass covers which can be customized on request.

The upper part of the glass is backlit (to illuminate the room number or a logo - both customizations on request); in the lower part there are 3 freely configurable backlit capacitive buttons.

For TR00C01KNX: 1 button (typically with bell function) and 2 LEDs for displaying the MUR and DND states

For TH00C01KNX: 1 button (typically with CAMERA LIGHTS function) and 2 buttons for setting MUR and DND

The transponder is read by placing it in front of the reader, at a maximum distance of 20 mm; in the case of the transponder pocket, the card is inserted into a compartment from the top of the device. The color of the reader RGB LED bar indicates that the card has been recognized and shows different (configurable) colors for status or anomalies reporting. The reader also integrates a buzzer (which can be activated with the ETS parameter) for anomalies signaling. Device is equipped with KNX communication interface.



Order Codes

KNX Transponder Holder

TH00C01KNX-1

Transponder Holder with 3 control buttons
White

TH00C01KNX-3

Transponder Holder with 3 control buttons
Black

Transponder Holder RGB Line Series Covers

9025PTH03L01

Single plexiglass - White

9025PTH03L03

Single plexiglass - Black

9025GTH03L01

Single glass - White

9025GTH03L03

Single glass - Black

Technical Features

Mechanical data	<ul style="list-style-type: none"> • Dimensions: (W x H x D) 96 x 96 x 41,6 mm
Mounting	<ul style="list-style-type: none"> • British box, German box or Italian 2 modules box
Supply	<ul style="list-style-type: none"> • Via bus EIB/KNX cable: 21 ÷ 32 Vdc • Auxiliary supply: 12 ÷ 24 Vdc / ac
Rear Input - digital mode	<ul style="list-style-type: none"> • For free potential contacts (dry contacts) • Max. length of Connecting Cables ≤ 10 m (twisted cable)
Rear input - analog mode for temperature probe	<p>For NTC temperature probe eelectron code:</p> <ul style="list-style-type: none"> • TS01A01ACC (range from -20°C to +100°C) • TS01B01ACC (range from -50°C to +60°C) • TS01D01ACC (range from -40°C to 125°C) • Max. length of Connecting Cable: ≤ 30 m (twisted cable)

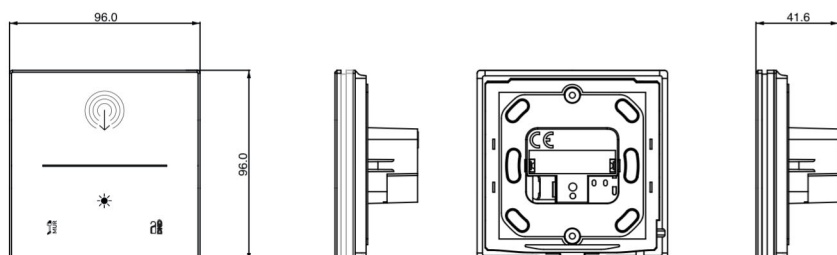

2 Modules Version

KNX Transponder Holder



TH00C01KNX-1
Transponder Holder with 3 control buttons - White



TH00C01KNX-3
Transponder Holder with 3 control buttons - Black

Transponder Holder Covers | RGB Line Series



9025PTH03L01
Single plexiglass - White



9025PTH03L03
Single plexiglass - Black



9025GTH03L01
Single glass - White



9025GTH03L03
Single glass - Black

9025 Access Control

KNX TRANSPONDER HOLDER

The 9025 series devices dedicated to access control management are KNX® devices and use RFID - MIFARE® technology. The range includes: TR00C01KNX: Doorpanel transponder reader, TH00C01KNX: Transponder holder, TE00C01KNX: Transponder card programmer.

The products are intended to be installed with the glass covers which can be customized on request.

The upper part of the glass is backlit (to illuminate the room number or a logo - both customizations on request); in the lower part there are 3 freely configurable backlit capacitive buttons.

For TR00C01KNX: 1 button (typically with bell function) and 2 LEDs for displaying the MUR and DND states

For TH00C01KNX: 1 button (typically with CAMERA LIGHTS function) and 2 buttons for setting MUR and DND

The transponder is read by placing it in front of the reader, at a maximum distance of 20 mm; in the case of the transponder pocket, the card is inserted into a compartment from the top of the device. The color of the reader RGB LED bar indicates that the card has been recognized and shows different (configurable) colors for status or anomalies reporting. The reader also integrates a buzzer (which can be activated with the ETS parameter) for anomalies signaling. Device is equipped with KNX communication interface.



Order Codes

Transponder Holder

TH00C01KNX-1-3M

Transponder Holder with 3 control buttons
3 Modules - White

TH00C01KNX-3-3M

Transponder Holder with 3 control buttons
3 Modules - Black

Transponder Holder RGB Line Series Covers

9025PTR303L01

Single plexiglass - 3 Modules - White

9025PTR303L03

Single plexiglass - 3 Modules - Black

9025GTR303L01

Single glass - 3 Modules - White

9025GTR303L03

Single glass - 3 Modules - Black

Technical Features

Mechanical data	<ul style="list-style-type: none"> • Dimensions: (W x H x D) 126 x 96 x 36 mm
Mounting	<ul style="list-style-type: none"> • British box, German box or Italian 2 or 3 modules box
Supply	<ul style="list-style-type: none"> • Via bus EIB/KNX cable: 21 ÷ 32 Vdc • Auxiliary supply: 12 ÷ 24 Vdc / ac
Rear Input - digital mode	<ul style="list-style-type: none"> • For free potential contacts (dry contacts) • Max. length of Connecting Cables ≤ 10 m (twisted cable)
Rear input - analog mode for temperature probe	<p>For NTC temperature probe eelectron code:</p> <ul style="list-style-type: none"> • TS01A01ACC (range from -20°C to +100°C) • TS01B01ACC (range from -50°C to +60°C) • TS01D01ACC (range from -40°C to 125°C) • Max. length of Connecting Cable: ≤ 30 m (twisted cable)

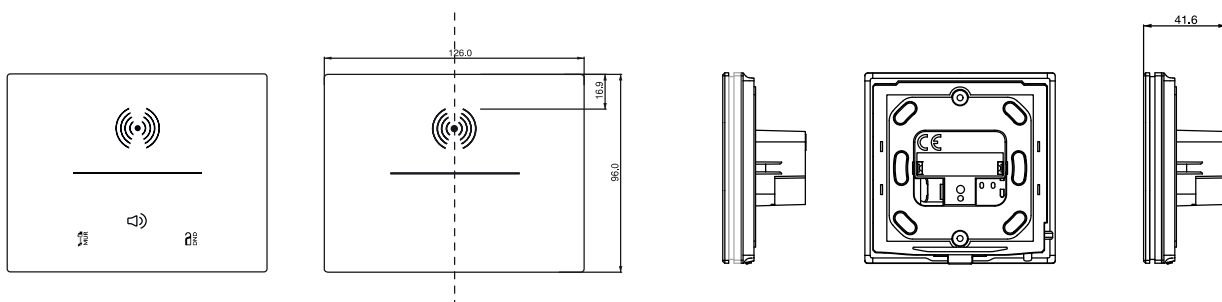

KNX Transponder Holder



TH00C01KNX-1-3M
Transponder Holder with 3 control buttons 3 Modules - White



TH00C01KNX-3-3M
Transponder Holder with 3 control buttons 3 Modules - Black

Transponder Holder Covers | RGB Line Series



9025PTH303L01
Single plexiglass - 3 Modules - White



9025PTH303L03
Single plexiglass - 3 Modules - Black



9025GTH303L01
Single glass - 3 Modules - White



9025GTH303L03
Single glass - 3 Modules - Black

9025 Access Control

KNX TRANSPONDER ENCODER

It is a USB desktop device compatible with USB-HID specification.
 It is a device designed to program cards or RFID devices used for Eelectron access control.
 No drivers are required to use this device with the dedicated software module.
 It's powered by the PC USB port to which is connected.



Order Codes

TE00C01USB
 Transponder Encoder USB - Black

Technical Features

Mechanical data

- Case: plastic (PC-ABS) / Aluminum
- Dimensions: (W x H x D): 96 x 98 x 100 mm
- Weight: ca. 320 g.

Power Supply

- Via bus USB: 5 V DC
- Current Consumption: max 160 mA @ 5 V

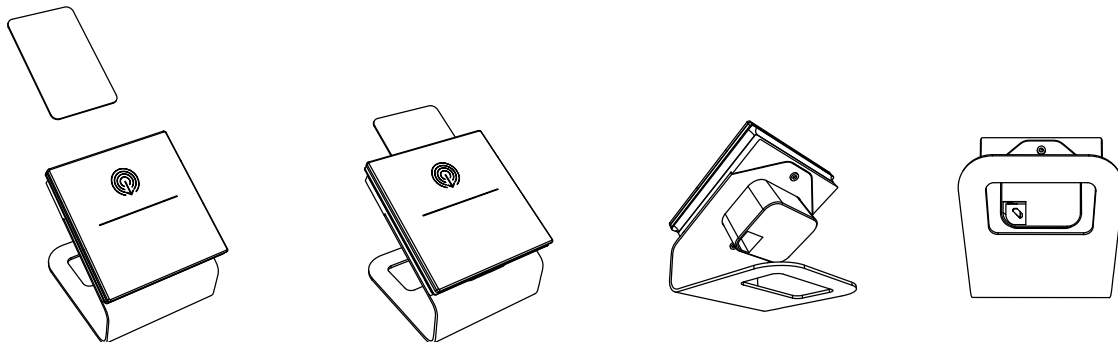

MIFARE Accessories

TRANSPONDER CARD MIFARE 1K

The card CD00M01TRC is based on MIFARE 1K Classic technology,

TRANSPONDER FITBAND MIFARE 1K

CD00M04TRB is a wristband, in polyurethane, with a unique and modern design.

Comfortable, water resistant and easy to wear, the case of this product can be customized with silkscreen colour printing, and epoxy.

Ideal for access control in recreational clubs, amusement parks, spa and swimming pools, it is available in black, blue, pink and yellow.

TRANSPONDER KEYHOLDER MIFARE 1K

The keyholder CD00M02TRK is based on MIFARE 1K Classic technology.

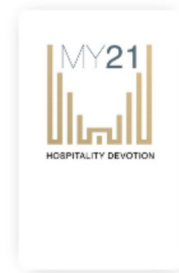

Technical Features

RFID Features	<ul style="list-style-type: none"> • Frequency: 13.56 MHz
Chip	<ul style="list-style-type: none"> • IC type: MIFARE 1K Classic EV1 (Type 4) • Memory size: 1024 Byte • UID: 4 o 7 Byte • Standard protocol: ISO 14443A • Reading distance: Up to 5 cm (dep. upon the reader)
Mechanical data	<p>Card</p> <ul style="list-style-type: none"> • Dimensions: (mm): 86x54 • Material: PVC <p>Fitband</p> <ul style="list-style-type: none"> • Size (mm): 205x15 ø 55 • Weight (g): 19 • Material housing: Polyurethane <p>Keyholder</p> <ul style="list-style-type: none"> • Size (mm): 40.5x32x4.2 • Weight (g): 6 • Material housing: ABS • Attachment: Key ring
Customization:	<p>Card</p> <ul style="list-style-type: none"> • Printing: silkscreen color print, digital print, offset print, thermal printing • Colour: white <p>Fitband</p> <ul style="list-style-type: none"> • Printing: silkscreen color print, and epoxy • Colour: black, blue, pink, yellow <p>Keyholder</p> <ul style="list-style-type: none"> • Printing: epoxy, silkscreen color print • Colour: blue, black, green, grey, yellow, red, white

Order Codes

CD00M02TRC

Transponder Card MIFARE 1K - 50 pcs. White

CD00M03TRC

Transponder Card MIFARE 1K - 200 pcs. White

CD00M02TRK

Transponder Keyholder MIFARE 1K 50 pcs.

CD00M04TRB

Transponder Wearable (bracelet) MIFARE 1K - 50 pcs.

CD00Q02TRC

Transponder Combo Card - MIFARE 1K 125 KHz - 50 pcs. - White

CD00Q03TRC

Transponder Combo Card - MIFARE 1K 125 KHz - 200 pcs. - White

CD00A02TRC

Transponder Card - 125 KHz - 50 pcs. White

CD00A03TRC

Transponder Card - 125 KHz - 200 pcs. White

CD00B02KNX

Transponder Card - 125 KHz - 50 pcs.

9025 Access Control

KNX NUMERIC KEYPAD

The 9025 KNX® numeric keypad dedicated to access control management consists of 10-channel capacitive buttons. The product can be installed with glass covers, white or black, which show the numbers from 0 to 9 which can be backlit. Device includes a 2 stage Room Temperature Controller with integrated PI to control heating and cooling equipments, valves, 2 and 4 pipes fan coils; etc.. Device has an embedded temperature sensor and a rear 2 poles connector configurable as digital or analog input; It's possible to connect an additional NTC temperature probe (eelectron codes TS01A01ACC or TS01B01ACC - not included) to perform a direct temperature measurement. The device includes an RGB LED bar on the front side of the numeric keypad in order to visualize the recognition of the entered code and shows different colors (configurable) for status or anomalies reporting such as:

- Password recognized (welcome): default Green color
- Incorrect system code: default color Orange
- Password not recognized: default color Red
- Incorrect Date Password (validity expired): default color Yellow
- Wrong time of day (Entry prohibited time): default color Magenta
- Wrong day of the week (Entry prohibited day): default color Blue-Cyan

The numeric keypad also integrates a buzzer that can be enabled or disabled in order to give acoustic feedback when a key is pressed.

The 9025 KNX® numeric keypad is mounted in 2 or 3 modules box and is compliant with main standards (British, German, Italian, etc).

Device is equipped with KNX communication interface.

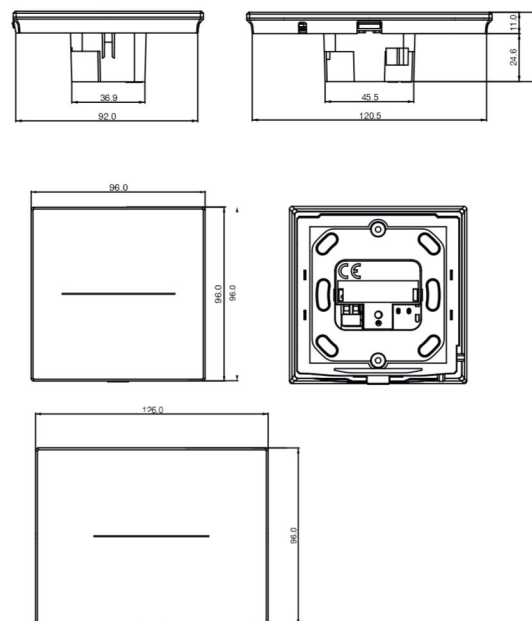

Technical Features

Mechanical data	<ul style="list-style-type: none"> • Dimensions (2 modules): (W x H x D): 96 x 96 x 36 mm • Dimensions (3 modules): (W x H x D): 126 x 96 x 36 mm
Mounting	<ul style="list-style-type: none"> • British box, German box or Italian 2 or 3 modules box
Supply	<ul style="list-style-type: none"> • Via bus USB: 5 V DC • max 20 mA @ 29V • max 24 mA @ 21V • (economy mode) max 12 mA @ 29V
Rear Input - digital mode	<ul style="list-style-type: none"> • For free potential contacts (dry contacts) • Max. length of Connecting Cables ≤ 10 m (twisted cable) • Voltage Scanning: 3,3 V DC (internally generated)
Rear input - analog mode for temperature probe	<p>For NTC temperature probe eelectron code:</p> <ul style="list-style-type: none"> • TS01A01ACC (range from -20°C to +100°C) • TS01B01ACC (range from -50°C to +60°C) • TS01D01ACC (range from -40°C to 125°C) • Max. length of Connecting Cable: ≤ 30 m (twisted cable)

Order Codes

- KP10C01KNX-1**
KNX capacitive numeric keypad for access control - White
- KP10C01KNX-3**
KNX capacitive numeric keypad for access control - Black
- KP10C01KNX-1-3M**
KNX capacitive numeric keypad for access control 3 Modules - White
- KP10C01KNX-3-3M**
KNX capacitive numeric keypad for access control - 3 Modules - Black
- 9025GKP10L01**
Single Glass Cover - White
- 9025GKP10L03**
Single Glass Cover - Black
- 9025GKP310L01**
Single Glass Cover - 3 Modules - White
- 9025GKP31L03**
Single Glass Cover - 3 Modules - Black

KNX Capacitive Switch Boards



KP10C01KNX-1
KNX capacitive numeric keypad for access control - White



KP10C01KNX-3
KNX capacitive numeric keypad for access control - Black



KP10C01KNX-1-3M
KNX capacitive numeric keypad for access control 3 modules - White



KP10C01KNX-3-3M
KNX capacitive numeric keypad for access control - 3 moduli - Black

Numeric Keypad Covers | RGB Line Series



9025GKP10L01
Single Glass Cover - White



9025GKP10L03
Single Glass Cover - Black



9025GKP310L01
Single Glass Cover - 3 Modules - White



9025GKP310L03
Single Glass Cover - 3 Modules - Black

9025

BEDSIDE PANEL

9025 custom Bedside Panel includes the features of the Standard 9025 switch: consists of 2 – 4 – 8 – 10 channels capacitive buttons. Each button can be configured to manage on/off commands, dimming, shutters and venetians control, scene recall and control, objects sequences etc; device includes a 2 stage Room Temperature Controller with integrated PI to control heating and cooling equipments, valves, 2 and 4 pipes fan coils; etc. Device has an embedded temperature sensor and a rear 2 poles connector configurable as digital or analog input; It's possible to connect an additional NTC temperature probe (electron codes TS01A01ACC - TS01B01ACC – TS01D01ACC not included) to perform a direct temperature measurement.

The glass bedside panel, as in the CUSTOM version of the 9025 series, has the possibility of back lighting custom and interchangeable icons matching with the associated function. The product is intended to fulfill the request of the hotel market including high possibility of customization through dedicated icons set, two sockets (not included) and a minimal elegant design.

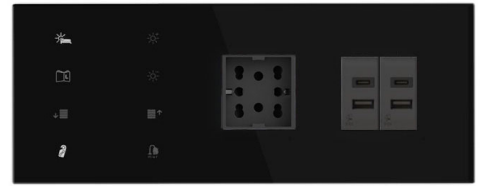
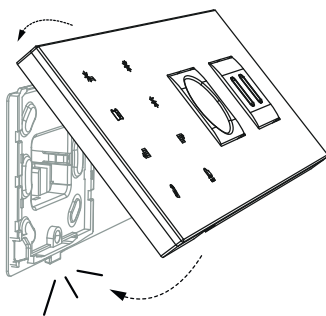
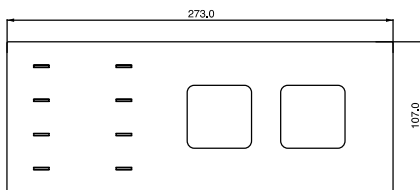

Order Codes

KNX Capacitive Switch Boards

CS05B01KNX-1

KNX Capacitive switch - White

CS05B01KNX-3

KNX Capacitive switch - Black

Bedside Panel Plate

9025GL10C01-B2R

Custom Bedside Panel Plate - 2 Sockets - Right White

9025GL10C03-B2R

Custom Bedside Panel Plate - 2 Sockets - Right Black

9025GL10C01-B2L

Custom Bedside Panel Plate - 2 Sockets - Left White

9025GL10C03-B2L

Custom Bedside Panel Plate - 2 Sockets - Left Black

KNX Capacitive Switch Boards



CS10A01KNX-1
Capacitive switch KNX - White



CS10A01KNX-3
Capacitive switch KNX - Black

Custom Bedside Panel Plate



9025GL10C01-B2R
Custom bedside panel plate – 2 sockets -
Right - White



9025GL10C03-B2R
Custom bedside panel plate – 2 sockets -
Right - Black



9025GL10C01-B2L
Custom bedside panel plate – 2 sockets -
Left - White



9025GL10C03-B2L
Custom bedside panel plate – 2 sockets -
Left - Black

9025 Access Control

DOOR PANEL

The KNX® 9025 capacitive doorpanel is a capacitive switch with RGB led bar; it is used in combination with the glass covers available in black or white; these cover glasses can be ordered in a specific version for the required application. The upper part of the glass can have a personalized, backlit room number; the lower part provides a key for the bell function, one for the 'do not disturb' function (DND) and one for the 'make up room' function (MUR). 2 other buttons customizable on request are available.

Device includes a 2 stage Room Temperature Controller with integrated PI to control heating and cooling equipments, valves, 2 and 4 pipes fan coils; etc. Device has an embedded temperature sensor and a rear 2 poles connector configurable as digital or analog input; It's possible to connect an additional NTC temperature probe (eelectron codes TS01A01ACC - TS01B01ACC – TS01D01ACC not included) to perform a direct temperature measurement. Device has a RGB led bar on the front side in order to visualize feedbacks or other values available over the KNX bus (function available on the RGB range).

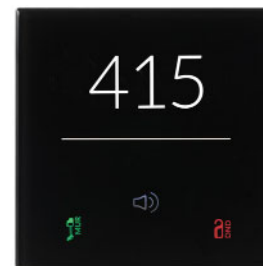

Order Codes

KNX Capacitive Switch Boards

CS05B01KNX-1

KNX Capacitive switch - White

CS05B01KNX-3

KNX Capacitive switch - Black

Door Panel Covers

9025GL03P01

Door panel 2 ch. - White + RGB

9025GL03P03

Door panel 2 ch. - Black + RGB

Technical Features

Mechanical data	<ul style="list-style-type: none"> • Dimensions: (W x H x D) 96 x 96 x 36 mm
Mounting	<ul style="list-style-type: none"> • British box, German box or Italian 2 modules box
Rear Input - digital mode	<ul style="list-style-type: none"> • For free potential contacts (dry contacts) • Max. length of Connecting Cables ≤ 10 m (twisted cable)
Rear input - analog mode for temperature probe	<p>For NTC temperature probe eelectron code:</p> <ul style="list-style-type: none"> • TS01A01ACC (range from -20°C to +100°C) • TS01B01ACC (range from -50°C to +60°C) • TS01D01ACC (range from -40°C to 125°C) • Max. length of Connecting Cable: ≤ 20 m (twisted cable)

KNX Capacitive Switch Boards



CS05B01KNX-1
KNX Capacitive switch door panel - White



CS05B01KNX-3
KNX Capacitive switch door panel - Black

Door Panel RGB Line Covers



9025GL03P01
Door panel 2 ch. - Single glass - White + RGB
DND/MUR + Bell



9025GL03P03
Door panel 2 ch. - Single glass - Black + RGB
DND/MUR + Bell

Transponder Reader

The Synchronicity series devices dedicated to access control management are KNX devices and use RFID - MIFARE® technology.

The transponder is read by placing it in front of the reader, at a maximum distance of 20 mm; in the case of the transponder pocket, the card is inserted into a compartment from the top of the device.

The Synchronicity KNX range is mounted in 2 or 3 modules box and is compliant with main standards (British, German, Italian, etc).

Device is equipped with KNX communication interface.

The AC22D01KNX-3 external card reader is an EIB/KNX device dedicated to access control.

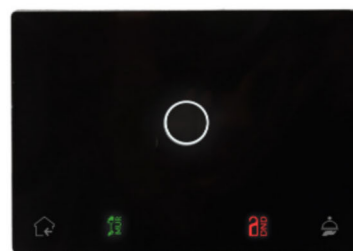

Technical Features

Mechanical data	<ul style="list-style-type: none"> Dimensions: (W x H x D) 96 x 96 x 36 mm
Mounting	<ul style="list-style-type: none"> British box, German box or Italian 2/3 modules box
Supply	<ul style="list-style-type: none"> Via bus EIB/KNX cable: 21 ÷ 32 Vdc Supplementary 12 ÷ 24 Vac/dc ± 10% 150 mA Max
Rear Input - digital mode	<ul style="list-style-type: none"> For free potential contacts (dry contacts) Max. length of Connecting Cables ≤ 10 m (twisted cable)
Output rate	<ul style="list-style-type: none"> Max load 24 Vac/dc, 2 A

Order Codes

TR22D01KNX-1
Transponder reader 13.5MHz - White

TR22D01KNX-3
Transponder reader 13.5MHz - Black

AC22D01KNX-3
Outdoor transponder reader 13.5MHz,
2IN/2OUT - Black

PX10A24ACC
Plexi plate for Outdoor reader - White

PX15A14ACC
Plexi plate for Outdoor reader - Black

Transponder Holder

The Synchronicity series devices dedicated to access control management are KNX devices and use RFID - MIFARE® technology.

The products are intended to be installed with the plexiglass covers which can be customized on request.

The transponder is read by placing it in front of the reader, at a maximum distance of 20 mm; in the case of the transponder pocket, the card is inserted into a compartment from the top of the device.

The Synchronicity KNX range is mounted in 2 or 3 modules box and is compliant with main standards (British, German, Italian, etc).

Device is equipped with KNX communication interface.

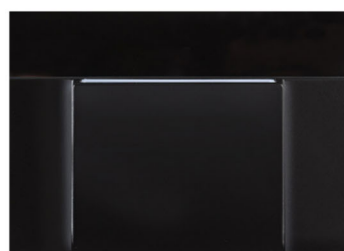

Technical Features

Mechanical data	<ul style="list-style-type: none"> • Dimensions: (W x H x D) 96 x 96 x 36 mm
Mounting	<ul style="list-style-type: none"> • British box, German box or Italian 2/3 modules box
Supply	<ul style="list-style-type: none"> • Via bus EIB/KNX cable: 21 ÷ 32 Vdc • Supplementary 12 ÷ 24 Vac/dc ± 10% 150 mA Max
Rear Input - digital mode	<ul style="list-style-type: none"> • For free potential contacts (dry contacts) • Max. length of Connecting Cables ≤ 10 m (twisted cable)
Output rate	<ul style="list-style-type: none"> • Max load 24 Vac/dc, 2 A

Order Codes

TH22D01KNX-1

Transponder holder 13.5Mhz - White

TH22D01KNX-3

Transponder holder 13.5Mhz - Black

eSuite Software

eSuite software is dedicated for hotel management, for the supervision of KNX environments, access control and alarms. The software can be interfaced with BMS. Client remote management can be done via Internet or Ethernet. The package is available with Embedded PC including 2 clients.

Technical Features

- Number of pages according to installed license.
- Number of clients according to installed license
- Up to 10 profiling groups
- Unlimited users
- Advanced ETS project data import
- Interfaced to third parties PMS
- Timer management
- Alarms management



Order Codes

SW01F11ACS

Embedded pc with eSuite sw – full package – 0 clients - closed license - 10 Rooms

SW01F01ACS

Embedded pc with eSuite sw – full package – 2 clients - start up license

SW01F10ACS

Embedded pc with eSuite sw – license – cost per single room

SW07D05KNX

Embedded rack pc with eSuite sw - full package – 2 clients - start up license

SW00D03KNX

eSuite additional client

SW00D04KNX

eSuite interface to management system

SW00D04DVL

eSuite connectivity to PMS custom development

SW00D06KNX

eSuite connectivity to Horizone & Virtual Badge applications

SW00T05KNX

eSuite IP (tunneling) module/unit price per IP node

eSuite Staff Experience for Staff daily operations

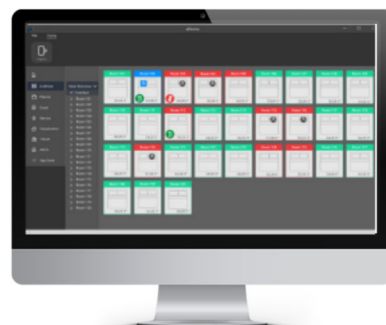
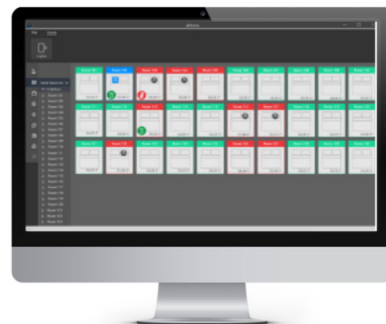
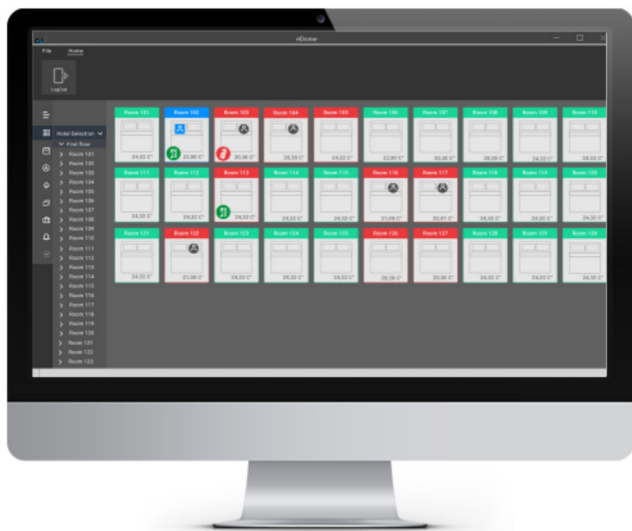

Hotel Backoffice Applications Connectivity

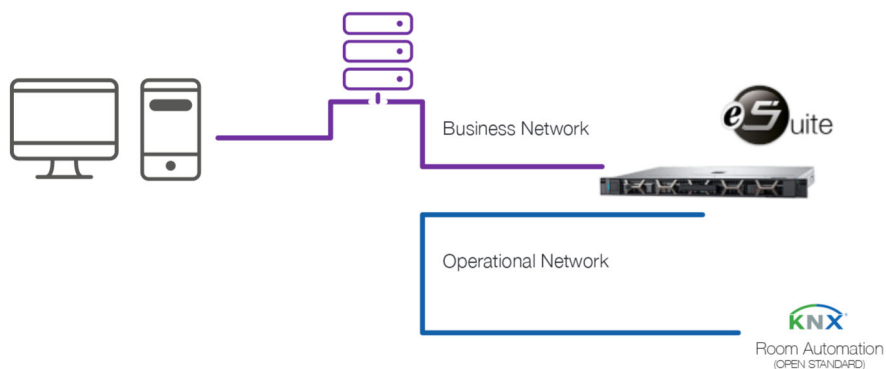

- Property Management Systems
- E-Lock Servers or in room applications
- Other IP related services

55x55 KNX Switch

4 CHANNELS + THERMOSTAT

SB40AxxKNX is a KNX tactile 4 channels push button which can be configured to manage on/off commands, dimming, shutters and venetians control, scene recall and control, sequences of 3 objects, etc. Device includes a 2 stage Room Temperature Controller with integrated PI to control heating and cooling equipments, valves, 2 and 4 pipes fan coils, etc. Device has a rear connector (2 poles) configurable as digital or analog input. It's possible to connect a NTC temperature probe (eelectron codes TS01A01ACC - TS01B01ACC - TS01D01ACC not included) to have a direct temperature measurement. SB40AxxKNX has a RGB led bar on the front side in order to visualize feedbacks or other values available over the KNX bus. SB40AxxKNX is intended to be used in British box, German box or Italian 2 modules box. Device is equipped with KNX communication interface.



Order Codes

SB40A01KNXPLCR

Knx switch 4 channels + Thermostat
55x55mm - Chromo - Plastic

SB40A11KNXPLBL

Knx switch 4 channels + Thermostat
55x55mm - Black - Plastic

SB40A21KNXPLWH

Knx switch 4 channels + Thermostat
55x55mm - White - Plastic

SB40A09KNXPLCR

Knx switch 4 channels + Thermostat
55x55mm - Chromo - Plastic + Linemark

SB40A19KNXPLBL

Knx switch 4 channels + Thermostat
55x55mm - Black - Plastic + Linemark

SB40A29KNXPLWH

Knx switch 4 channels + Thermostat
55x55mm - White - Plastic + Linemark

SB40A01KNXMT60

Knx switch 4 channels + Thermostat
55x55mm - Chromo + Alluminium

(Order codes are referred only to switches without frames).

Technical Features

Mechanical data	<ul style="list-style-type: none"> Dimensions: (H x W x D) : 55 x 55 x 37 mm
Mounting	<ul style="list-style-type: none"> British box, German box or Italian 2 modules box
Supply	<ul style="list-style-type: none"> Via bus EIB/KNX cable: 21 ÷ 32 Vdc
Rear Input - digital mode	<ul style="list-style-type: none"> For free potential contacts (dry contacts) Max. length of Connecting Cables ≤ 10 m (twisted cable)
Rear input - analog mode for temperature probe	<p>For NTC temperature probe eelectron code:</p> <ul style="list-style-type: none"> TS01A01ACC (range from -20°C to +100°C) TS01B01ACC (range from -50°C to +60°C) TS01D01ACC (range from -40°C to 125°C) Max. length of Connecting Cable: ≤ 20 m (twisted cable)

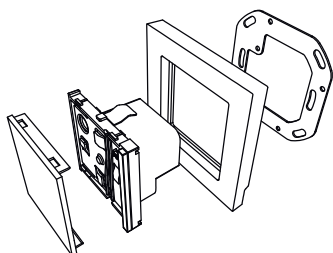
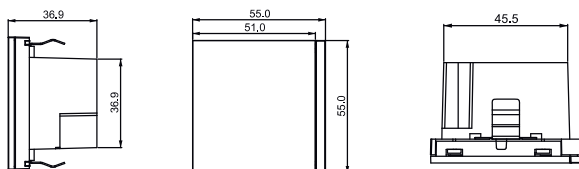

Plastic



Chromo
SB40A01KNX-PLCR



Black
SB40A11KNX-PLBL



White
SB40A21KNX-PLWH

Plastic + Linemark



Chromo
SB40A09KNX-PLCR



Black
SB40A19KNX-PLBL



White
SB40A29KNX-PLWH

Metal



Aluminium
SB40A01KNX-MT60

9025 KNX Touch Panel 3,5"

EVO21

The touch panel is equipped with a 3,5 inches coloured display; dimming, status, values, lighting, shutters and timers are controlled and password protected when needed. Using the embedded temperature sensor and the embedded room temperature controller function is possible to manage valves, fancoil or other HVAC equipments. The device includes a number of pre-programmed logic including control of electrical loads with automatic power-off priority, (this feature is available in combination with eelectron KNX power measuring device). The panel 3.5 "Touch has an LED for status display and a buzzer to give sound signals with alarm function.

The device is equipped with a Micro-USB connection accessible from the front by simply removing the external cover; allows connection to the programming device for customizing icons, screensavers or logics. Similarly, a Micro-SD Card slot is available for updating the device's firmware. Available in two colours (white and black) is based on Linux OS but can be programmed using only ETS without any additional SW.

Device is equipped with KNX communication interface



Technical Features

Mechanical data	<ul style="list-style-type: none"> • Dimensions: (W x H x D) : 96 x 96 x 15 mm
Mounting	<ul style="list-style-type: none"> • Inwall box: 2 modules Italian, German box, Swiss box
Supply	<ul style="list-style-type: none"> • Via bus EIB/KNX cable: 21 ÷ 32 Vdc • Auxiliary power supply: 9 ÷ 32 Vdc • Current Consumption (Aux): 55 mA @24 Vdc

Order Codes

TP35A01KNX-1
 Touch Panel KNX 3,5 EVO21 - White

TP35A01KNX-3
 Touch Panel KNX 3,5 EVO21 - Black

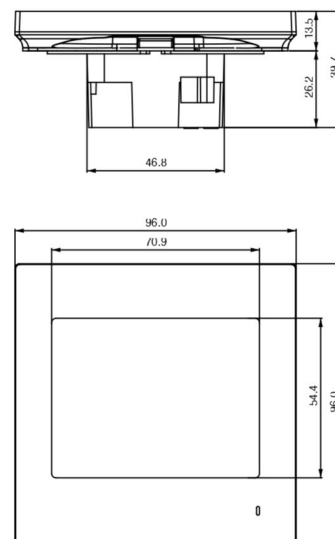
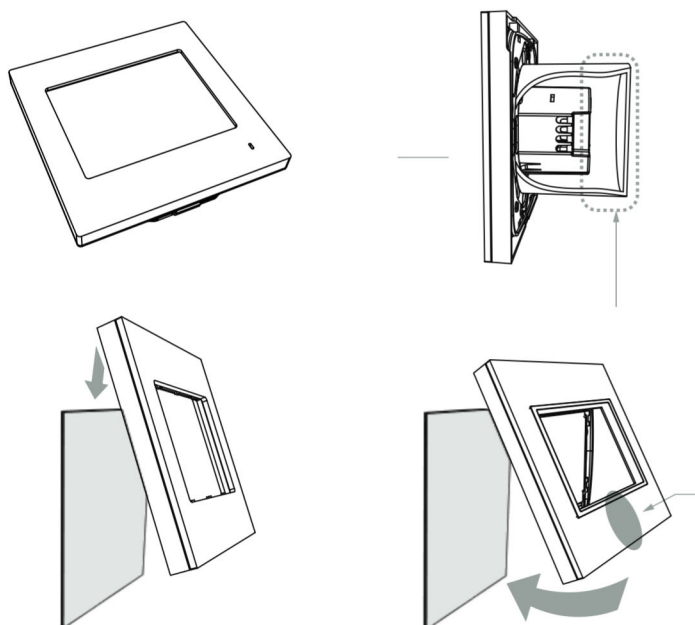

eelecta KNX Touch Panel 3,5"

The Eelecta touch panel: powerful control in a distinctive shape. With a coloured display, dimming, status, values, lighting, shutters and timers are controlled and password protected when needed. Using the embedded temperature sensor, chrono or fancoil controlling functions are managed. DMX coloured Led or lights are controlled with the optional DMX interface, and load control with automatic cut off of prioritized functions is performed with the available power meter. Based on Linux® OS but Ets programmed, the 3.5" touch panel has Led indicator for status display and an audio signal for alarm functions and is available in three colours.



Technical Features

Mechanical data	<ul style="list-style-type: none"> • Dimensions: (H x W x D) : 113 x 113 x 48mm
Mounting	<ul style="list-style-type: none"> • Inwall box: 2 or 3 modules Italian, German box, Swiss box
Supply	<ul style="list-style-type: none"> • Via bus EIB/KNX cable: 21 ÷ 32 Vdc • Auxiliary power supply: 9 ÷ 32 Vdc • Current Consumption (Aux): 55 mA @24 Vdc

Order Codes

- VS00E10KNX**
Touch Panel KNX 3,5 + Thermostat
Ceramic White
- VS00E20KNX**
Touch Panel KNX 3,5 + Thermostat
Chromo
- VS00E30KNX**
Touch Panel KNX 3,5 + Thermostat
Black Matte

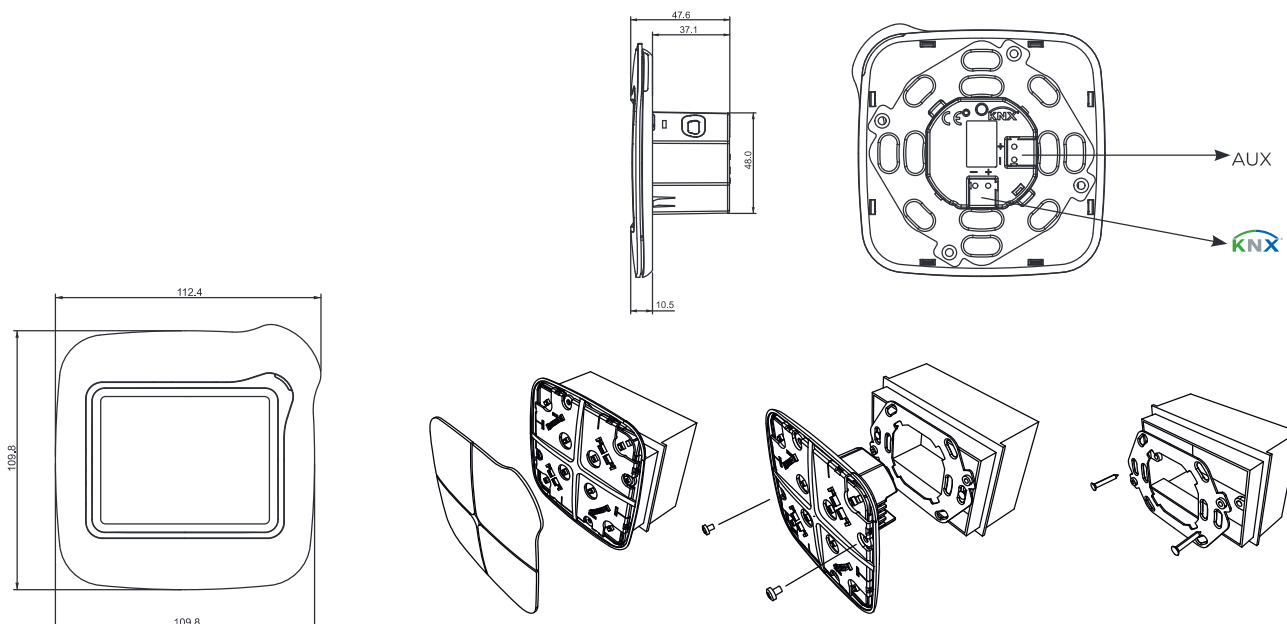

3025 KNX Touch Panel 3,5"

SQUARE



The 3025 Touch Panel: powerful control in a distinctive shape. With a coloured display, dimming, status, values, lighting, shutters and timers are controlled and password protected when needed. Using the embedded temperature sensor, chrono or fancoil controlling functions are managed. DMX coloured Led or lights are controlled with the optional DMX interface, and load control with automatic cut off of prioritized functions is performed with the available power meter. Based on Linux® OS but Ets programmed, the 3,5" Touch Panel has Led indicator for status display and an audio signal for alarm functions and is available in three colours.

Technical Features

Mechanical data	<ul style="list-style-type: none"> • Dimensions: (H x W x D): 113 x 113 x 48 mm
Mounting	<ul style="list-style-type: none"> • British box, German box or Italian 2 or 3 modules box
Supply	<ul style="list-style-type: none"> • Via bus EIB/KNX cable: 21 ÷ 32 Vdc • Auxiliary power supply: 9 ÷ 32 Vdc

Order Codes

VS00G10KNX

Touch Panel KNX 3,5 SQUARE
White Glass

VS00G11KNX

Touch Panel KNX 3,5 SQUARE
Ice White Glass

VS00G30KNX

Touch Panel KNX 3,5 SQUARE
Black Glass

VS00P10KNX

Touch Panel KNX 3,5 SQUARE
Plexi Glass

VS00P20KNX

Touch Panel KNX 3,5 SQUARE
Plexi Chromo

VS00P15KNX

Touch Panel KNX 3,5 SQUARE
Plexi Black

VS00W60KNX

Touch Panel 3,5" SQUARE
Metal

VS00W50KNX

Touch panel 3,5" SQUARE
Oak White

VS00W51KNX

Touch panel 3,5" SQUARE
Oak Black

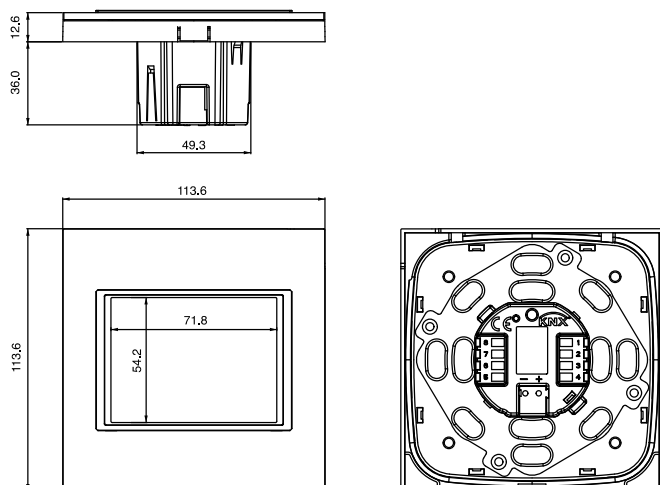

Plexiglass



White
VS00P10KNX



Black
VS00P15KNX

Glass



White
VS00G10KNX



Black
VS00G30KNX

MiniPad Evo21



Eeecta® Minipad pushbutton range of KNX devices is divided in 4 different models based on the number of switch, input and temperature sensors provided with the device. Product has 4 (8) push buttons which can be configured to manage lights, dimmers, shutters, etc; and 4 inputs (where present) on the backside to interface free potential contacts (for example sensors, traditional buttons, etc.) It has 5 white led in the front side, each led freely configurable by ets and 2 versions have a temperature sensor included which can be configured as a room thermostat.

The device is equipped with appropriate communication interface with the bus type TP1 (twisted pair) KNX European standard, according CEI EN 50090.

Order Codes

MB40B1FKNX-WH

4 channels KNX - White Ceramic

MB80C1FKNX-WH

8 channels KNX - TS/ Circular functions - White Ceramic

MB40B3FKNX-BL

4 channels KNX - Black Matte

MB80C3FKNX-BL

8 channels KNX - TS/ Circular functions - Black Matte

Technical Features

Mechanical data	<ul style="list-style-type: none"> • Dimensions (H. x W.) 90 x 90 mm
Mounting	<ul style="list-style-type: none"> • Inwall box: 2 modules Italian, German box, Swiss box
Supply	<ul style="list-style-type: none"> • Via bus EIB/KNX cable: 21 ÷ 32 Vdc
Rear Input - digital mode	<ul style="list-style-type: none"> • For free potential contacts (dry contacts) • Max. length of Connecting Cables \leq 10 m (twisted cable)

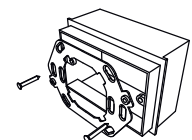
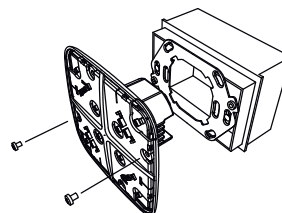
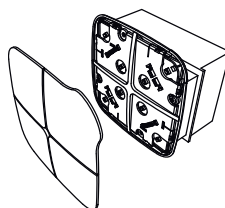
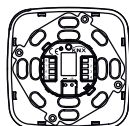
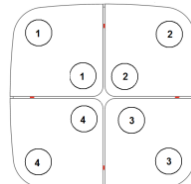
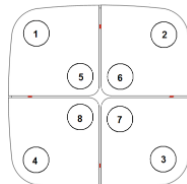
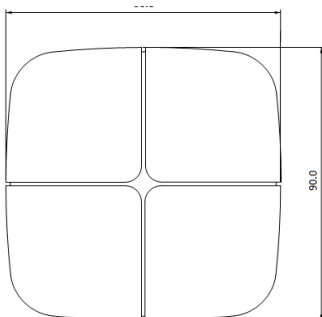

Linear Cover



Ceramic White-
COAW



Black Matte
COAA

MiniPad



Ceramic White - Opaline Center
1A - WH



Black Matte - Opaline Center
3C - BL

Horizone Web Server

HORIZONE is a webservice specifically engineered for supervision and monitoring of Home & Building Automation systems. Based on KNX standard and suitable for integration with Modbus standard and other technologies used in intelligent buildings, alarm systems, fire and smoke detections systems, audio/video distribution systems. Compatible with operating system Mac OS X, Microsoft Windows, Apple iOS and Google Android, the configuration and use of HORIZONE takes place directly through its web interface, which can be accessed through the most popular browser on the market browser from any device (pc/mac, smartphone e tablet) or with free app available on iOS and Android store.



SIZES

	KNX GROUP ADDRESSES	SCENES	LOGICS	PAGES	LOADS
Horizone Web Server 200 KNX group addresses	200	30	30	UNLIMITED	10
Upgrade up to 800 KNX group addresses	800	100	100	UNLIMITED	20
Upgrade up to 1400 KNX group addresses	1400	100	100	UNLIMITED	40

**On demand Horizone Upgrade over 1400 KNX group addresses

Order Codes

IN00B02WEB
Web Server Horizone 200 points

IN00B03UPG
Upgrade up to 800 points

IN00B04UPG
Upgrade up to 1400 points

Hardware Features

Mechanical data	<ul style="list-style-type: none"> Dimensions: 5 DIN modules
Supply	<ul style="list-style-type: none"> Via bus EIB/KNX cable: 21 ÷ 32 Vdc
Aux Supply	<ul style="list-style-type: none"> 12 ÷ 24 Vdc 18 mA @12 V; 110 mA @24 V
Communication ports	<ul style="list-style-type: none"> KNX RS232 (1x) Screw connector RS485 (1x) Screw connector USB 2.0 (2x) LAN (1x) RJ-45 jack (10/100 Mbps)

Additional Software Modules

IN00B02MBS	<ul style="list-style-type: none"> MODBUS Module for HORIZONE WS
IN00B02BEN	<ul style="list-style-type: none"> BENTEL Module for HORIZONE WS
IN00B02IES	<ul style="list-style-type: none"> ELMO/IESS Module for HORIZONE WS
IN00B02TEC	<ul style="list-style-type: none"> TECNOALARM Module for HORIZONE WS
IN00B02TUT	<ul style="list-style-type: none"> TUTONDO Module for HORIZONE WS
IN00B02VIV	<ul style="list-style-type: none"> VIVALDI Module for HORIZONE WS
IN00B02VOI	<ul style="list-style-type: none"> VOIP Module for HORIZONE WS
IN00B02SON	<ul style="list-style-type: none"> SONOS Module for HORIZONE WS
IN00B02DAT	<ul style="list-style-type: none"> Report and Accounting Module for HORIZONE WS

Software Features

Standard technologies	<ul style="list-style-type: none"> KNX RS232 / RS485 / TCP
User interface	<ul style="list-style-type: none"> Web / HTML5 App iOS / Android
Number of clients	<ul style="list-style-type: none"> Unlimited
Simultaneous connections	<ul style="list-style-type: none"> Up to 20
Features	<ul style="list-style-type: none"> Lighting HVAC Blinds / Shutters Irrigation Alarms Power consumption Load management Weather IP Camera Door intercom system (with SIP standard) Cloud services Voice control IFTTT
Advanced functions	<ul style="list-style-type: none"> Scenarios with parametrical wait functions Boolean logics Thresholds and values comparators Mathematical operations Scheduler Notifications Advanced logic module
Users and security	<ul style="list-style-type: none"> Unlimited users SSL Internet secure access

Horizon Web Server

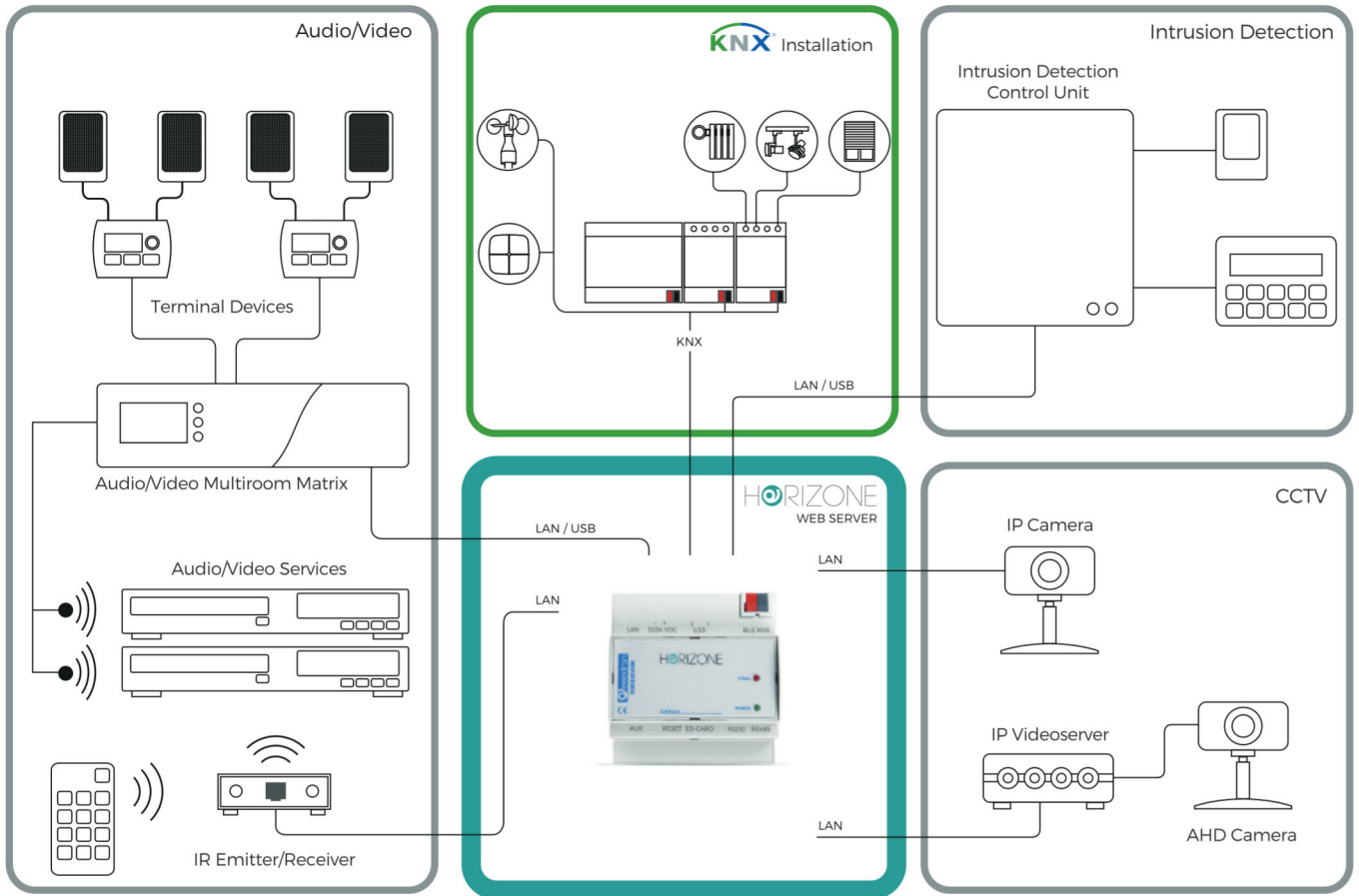

Horizone Virtual Badge

Virtual Badge is an innovative access control system, which allows the opening of gates with your smartphone, without the need for keys or badge readers physically installed in front of each door. The management of permission of the users, and the sending of virtual access keys, is entirely manageable via app, both locally and remotely, and is therefore ideal also for unattended structures.



Virtual Badge



Virtual Badge + Horizone Server

Target	<ul style="list-style-type: none"> • Access Control • Home automation management • Integration of bus and technological systems
Technology	<ul style="list-style-type: none"> • KNX • Anti-Intrusion Systems * • Audio Systems * • IP cameras * • Modbus *
Room 1-4	<ul style="list-style-type: none"> • Horizone Web Server + • Virtual Badge License + • Other license if required
Every 4 room	<ul style="list-style-type: none"> • Additional Virtual Badge License

* For compatibility list, see technical documentation for Horizone Web Server

Order Codes

- IN00B02RAC-04**
Access control module - 4 zones
- IN00B02RAC-08**
Access control module - 8 zones
- IN00B02RAC-12**
Access control module - 12 zones
- IN00B02RAC-16**
Access control module - 16 zones
- IN00B02RAC-20**
Access control module - 20 zones
- IN00B02RAC-24**
Access control module - 24 zones
- IN00B02RAC-28**
Access control module - 28 zones
- IN00B02RAC-30**
Access control module - 30 zones
- IN00B02RAC-32**
Access control module - 32 zones
- IN00B02RAC-34**
Access control module - 34 zones
- IN00B02RAC-38**
Access control module - 38 zones
- IN00B02RAC-40**
Access control module - 40 zones

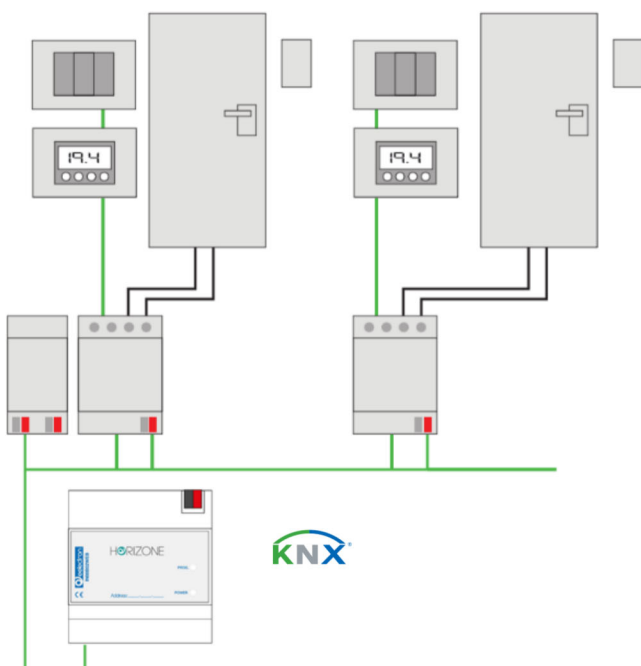

Horizone MINI Web Server

HORIZONE MINI is a webserver specifically engineered for supervision and monitoring of Home & Building Automation systems. Based on KNX standard and suitable for integration with Modbus standard*. Compatible with operating system Mac OS X, Microsoft Windows, Apple iOS and Google Android, the configuration and use of HORIZONE takes place directly through its web interface, which can be accessed through a the most popular browser on the market browser from any device (pc/mac, smartphone e tablet) or with free app available on iOS and Android store.

*Only for Modbus energy meter



Order Codes

IN00M02WEB
Horizone MINI Web Server 200 points

Software Features

Standard technologies	<ul style="list-style-type: none"> • KNX (max 200 group addresses) • RS485 / TCP • Energy meter USB
User interface	<ul style="list-style-type: none"> • Web / HTML5 • App iOS / Android
Number of clients	<ul style="list-style-type: none"> • Unlimited
Simultaneous connections	<ul style="list-style-type: none"> • Up to 20
Features	<ul style="list-style-type: none"> • Lighting • HVAC • Blinds / Shutters • Irrigation • Alarms • Energy management • Load management • Weather • Door intercom system (with SIP standard) • SONOS • Cloud services • Voice control • IFTTT
Advanced functions	<ul style="list-style-type: none"> • Scenarios with parametrical wait functions • Boolean logics • Thresholds and values comparators • Mathematical operations • Scheduler • Programmable events • Notifications

SIZES

	KNX GROUP ADDRESSES	SCENES	LOGICS	PAGES	LOADS
Horizone Web Server 200 KNX group addresses	200	30	30	12	10

Hardware Features

Dimensions	<ul style="list-style-type: none"> • 90,5 x 62 x 36 mm • 2 DIN rail Module
Aux Supply	<ul style="list-style-type: none"> • 12 ÷ 24 Vdc • 18 mA @12 V; 110 mA @24 V
Communication ports	<ul style="list-style-type: none"> • KNX • RS485 (1x) Screw connector • USB 2.0 (1x) • LAN (1x) RJ-45 jack (10/100 Mbps)

Energy Meter USB

USB ENERGY METER

This is an indirect insertion single-phase energy meter for DIN rail mounting and the connection is made via USB with the Horizone webserver or Horizone Mini.

Through the user interface of the web server to which it is connected, it allows monitoring of the power, voltage and current relative to the point where it is mounted. Thanks to the amperometric clamp supplied, with opening insertion, it is possible to measure any electrical phase available in the electrical panel, without having to intervene directly in the relative wiring. To work requires a free USB port on the Horizone or Horizone Mini webserver.

Order Codes

PM10M01USB
USB Energy Meter

IP Touch Panel 5"

Horizone IP Touch Panel is an Android based touch panel with a coloured 5" display in which can be installed third-party applications for the integration of different systems.

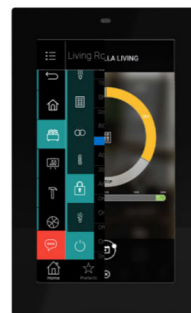

Technical Features

Dimensions:	<ul style="list-style-type: none"> • 81x132x14 mm • Inwall Box 2M – Ex. Bticino 502E • Inwall Box Round 60 Diameter – Ex. Gewiss 24232 • Inwall Box 3M – Ex. Bticino 503E
Orientation	<ul style="list-style-type: none"> • Horizontal or Vertical
Supply	<ul style="list-style-type: none"> • POE (Power Over Ethernet)
Monitor	<ul style="list-style-type: none"> • LCD HD IPS 5"
Resolution	<ul style="list-style-type: none"> • 1280x720 px
Color	<ul style="list-style-type: none"> • 16,7 Millions Colors (True Colors)
Brightness	<ul style="list-style-type: none"> • 400 nits
Touch Screen	<ul style="list-style-type: none"> • Capacitive with multi touch & gestures support
Speakers	<ul style="list-style-type: none"> • High definition audio through incorporated amps - 2 W
Microphone	<ul style="list-style-type: none"> • Integrated – echo canceling high resolution
Gyroscope	<ul style="list-style-type: none"> • Auto survey orientation
Proximity	<ul style="list-style-type: none"> • Integrated
Brightness Sensor	<ul style="list-style-type: none"> • Integrated
Connectivity	<ul style="list-style-type: none"> • LAN 100 baseIT
Certification	<ul style="list-style-type: none"> • CE / FCC CLASS B / FCC part 15 / ROHS / WEEE
Operating System	<ul style="list-style-type: none"> • Android 6

Order Codes

WS05H10WEB
Horizone Touch Panel 5" - Black

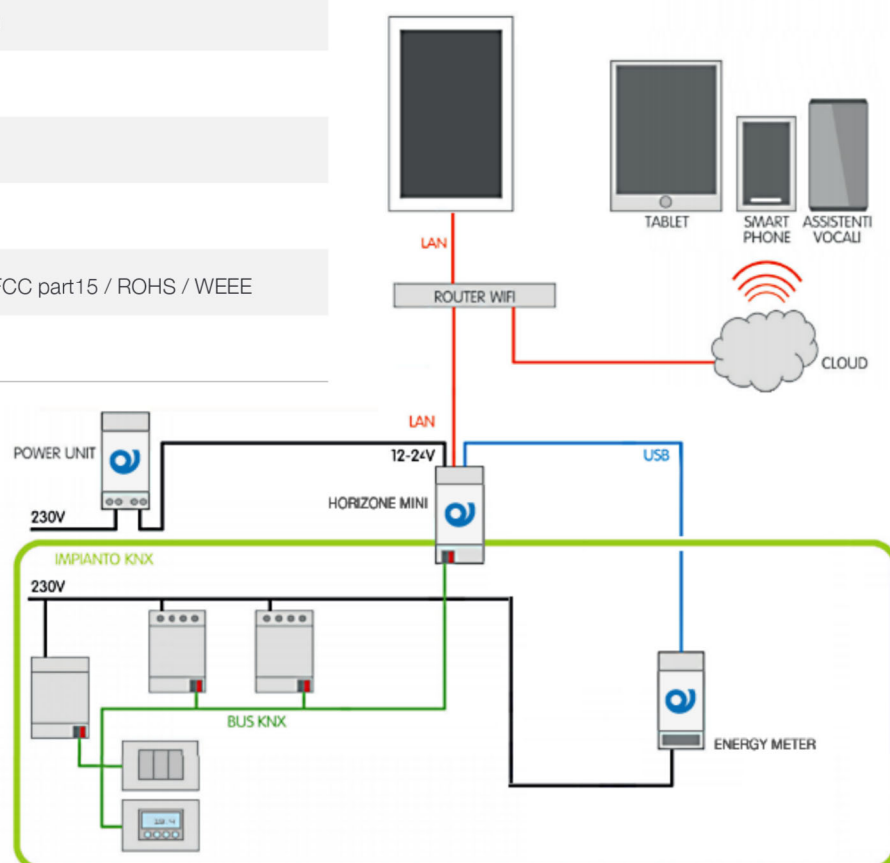
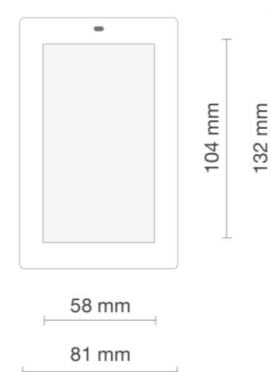

IP Touch Panel 8"

Horizone IP Touch Panel is an Android based touch panel with a coloured 8" display in which can be installed third-party applications for the integration of different systems.

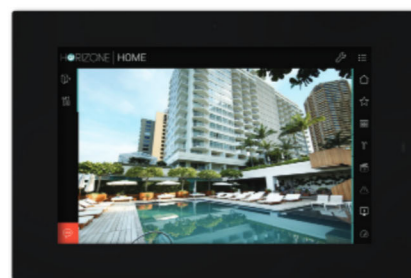

Technical Features

Dimensions:	<ul style="list-style-type: none"> • 224x149x16 • Inwall Box 154x98x69 mm – Ex. Bticino 16204
Orientation	<ul style="list-style-type: none"> • Horizontal or Vertical
Supply	<ul style="list-style-type: none"> • POE (Power Over Ethernet)
Type	<ul style="list-style-type: none"> • LCD HD IPS 8"
Resolution	<ul style="list-style-type: none"> • 1280x720 px
Color	<ul style="list-style-type: none"> • 16,7 Millions Colors (True Colors)
Brightness	<ul style="list-style-type: none"> • 400 nits
Touch Screen	<ul style="list-style-type: none"> • Capacitive with multi touch & gestures support
Speakers	<ul style="list-style-type: none"> • High definition audio through incorporated amps - 2 W
Microphone	<ul style="list-style-type: none"> • Integrated – echo canceling high resolution
Gyroscope	<ul style="list-style-type: none"> • Auto survey orientation
Proximity	<ul style="list-style-type: none"> • Integrated
Brightness Sensor	<ul style="list-style-type: none"> • Integrated
Connectivity	<ul style="list-style-type: none"> • LAN 100 baseT
Certification	<ul style="list-style-type: none"> • CE / FCC CLASS B / FCC part 15 / ROHS / WEEE
Operating System	<ul style="list-style-type: none"> • Android 6

Order Codes

WS05H10WEB
Horizone Touch Panel 8" - Black

WS05H20WEB
Horizone Touch Panel 8" - White

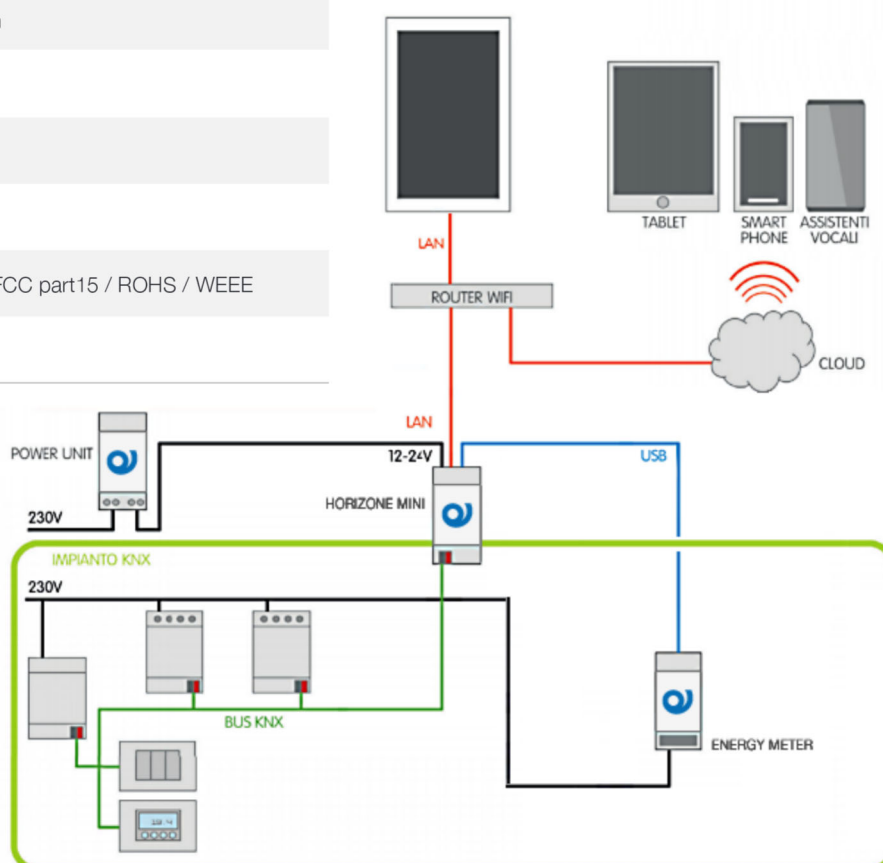

Actuators



Lighting Management
Dimming, DALI, DMX
Climate Control
Shutters Management
Sensors
Metering
System Components
Interfaces



Actuators, Dimmers, Presence Detectors, System components

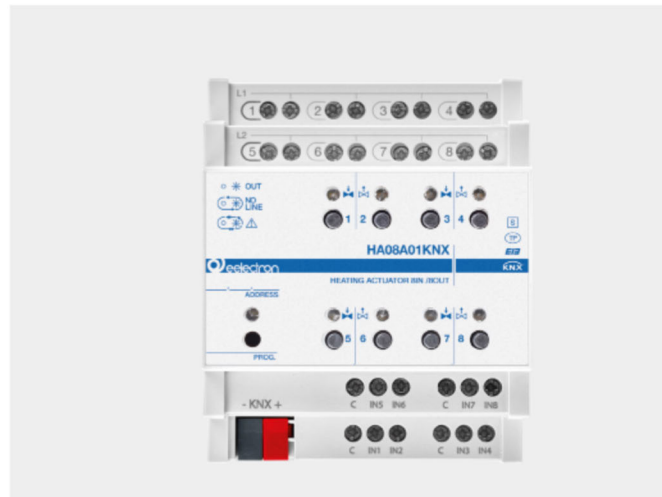
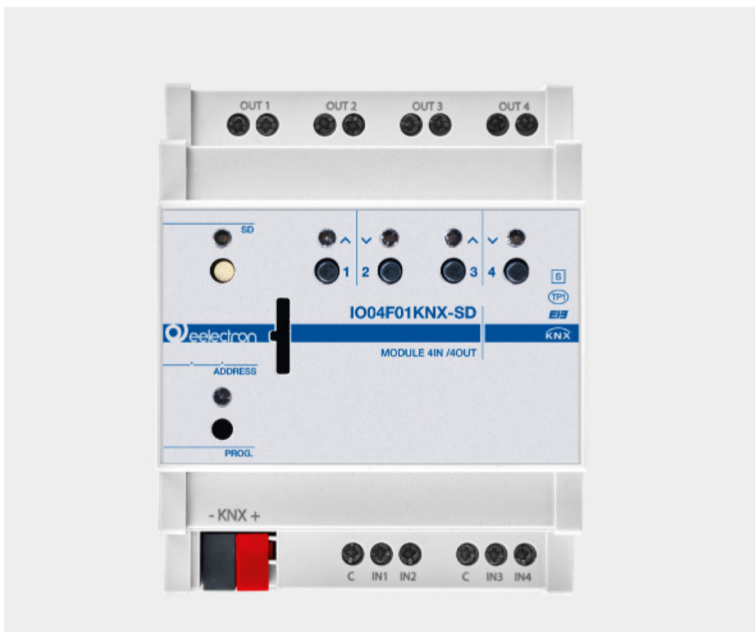

Universal actuator
16 IN / 16 OUT with
manual control

Universal actuator
4 IN / 4 OUT with
manual control

Heating actuator
8 IN / 8 OUT with
manual control

Universal actuator
16 OUT with
manual control

DALI Gateway TW
2 CH

Multi Sensor



Inwall Module

3 IN / 2 OUT

IO32D01KNX module includes: 2 digital inputs, 1 analog input, 2 relay outputs (bistable).

Digital inputs are intended to be connected to free potential contacts and can interface sensors, conventional push buttons, etc; they can be used for on/off controls, dimming, shutter control, scene recall and control, sequences of 3 objects. Analog input, can manage one temperature probe (with On/Off threshold) or one thermostats to control heating and cooling equipments, valves, 2 and 4 pipes fan coils; etc. Analog input, alternatively to the temperature sensor, can manage a Infrared Receiver (IRX) in order to forward to the bus up to 8 functions coming from a Infrared Remote Control (IRC) with on/off commands, scenes, sequences of 2 objects, dimmers and shutters. Outputs include switching functions with timed delays, stair-case functions, scene recall, lock or logic functions.

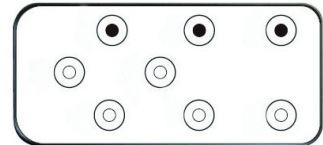
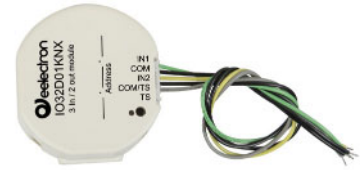

Technical Features

Mechanical data	<ul style="list-style-type: none"> • Dimensions: (Ø x H) 52 x 28 mm
Mounting	<ul style="list-style-type: none"> • Inwall
Supply	<ul style="list-style-type: none"> • Via bus EIB/KNX cable: 21 ÷ 32 Vdc
Input - digital mode	<ul style="list-style-type: none"> • For free potential contacts (dry contacts) • Max. length of Connecting Cables ≤ 30 m (twisted cable)
Input - analog mode for temperature probe	<ul style="list-style-type: none"> • For NTC temperature probe eelectron code: • TS01A01ACC (range from -20°C to +100°C) • TS01B01ACC (range from -50°C to +60°C) • TS01D01ACC (range from -40°C to 125°C) • Max. length of Connecting Cable: ≤ 20 m (twisted cable)
Input - analog mode for Infrared Receiver (IRX)	<ul style="list-style-type: none"> • These accessories must be used: • IR01A01ACC (IRX with cable and connector) • RC80A01IRC (IR remote control 8 channels)
Output rate	<ul style="list-style-type: none"> • 10 A cos φ 1 - 230 Vac • Max capacitance @230 V: 21 µF 5.000 cycles • Incandescent lamps max load: 1500 W 50.000 cycles • Fluorescent lamps max load: 6 x18 W 25.000 cycles • Halogen lamps max load: 500 W 50.000 cycles • Gas discharge lamps max load: 200 W 25.000 cycles

Order Codes

- IO32D01KNX**
Inwall Actuator 3 IN / 2 OUT
- IR00A01ACC**
IRX Cabling
- RC80A01IRC**
IRC Device

Universal Module

4 IN / 4 OUT PLUS — F Series

Device IO04F01KNX is a DIN rail EIB / KNX actuators with 4 relay outputs that can be configured as:

- 4 outputs for light / load control
- 4 channels for valve in PWM (solenoid actuators)
- 2 channels for roller shutter / venetian control
- 2 channels for 3-point valve control
- 1 fan coil actuators 2-pipes

The device also includes 4 inputs that can be connected to pushbuttons, switches, or be configured as outputs to activate individual signaling LEDs (eelectron code LD00A01ACC / LD00A11ACC) and can be used for on / off, dimming, shutters or venetian blinds / scenarios, sequences, step-by-step commands, etc. 4 inputs (of the 16) are configurable as analogue for the connection of NTC temperature probes (see probes eelectron code TS00A01ACC / TS00B01ACC) with which to send 4 temperature measurements on the bus and manage a simple on / off controls (e.g. thermo furniture).

It is also possible to enable 4 complete thermostat modules; each thermostat module manages 2 stages with integrated PI controller for driving heating and cooling equipment, valves, 2 and 4-pipe fan coils, etc.

Version IO04F01KNX-SD includes a microSD card reader includes a microSD card with which you can save the programming of the device to be able to restore it on an identical device in order to avoid programming in field or to allow a fast restore in case of failure.



Technical Features

Mechanical data	<ul style="list-style-type: none"> • Dimensions: 4 DIN modules
Supply	<ul style="list-style-type: none"> • Via bus EIB/KNX cable: 21 ÷ 32 Vdc
Input - digital mode	<ul style="list-style-type: none"> • For free potential contacts (dry contacts) • Max. length of Connecting Cables ≤ 30 m (twisted cable)
Input - analog mode for temperature probe	<ul style="list-style-type: none"> • For NTC temperature probe eelectron code: <ul style="list-style-type: none"> • TS01A01ACC (range from -20°C to +100°C) • TS01B01ACC (range from -50°C to +60°C) • TS01D01ACC (range from -40°C to 125°C) • Max. length of Connecting Cable: ≤ 20 m (twisted cable)
Output rate	<ul style="list-style-type: none"> • 16 A cos φ 1 - 230 Vac • 8 A cos φ 0.6 - 230 Vac • Max current relay output: 16 A/16 AX (140 μF) • Max peak current: 165 A / 20 ms • Incandescent lamps: max 10 A • Motors e motor reduction units: max 10 A • Fluorescent lamps (max 140 μF) max 3 A (700 W) • Electronic ballast: max 6 A • LED's lamps drivers: always check that the maximum peak current drawn by led power supply is lower than maximum peak current allowed for the relay

Order Codes

IO04F01KNX

Universal Actuator 4 IN / 4 OUT Plus

IO04F01KNX-SD

Universal Actuator 4 IN / 4 OUT + SD Card

Universal Module

8 IN / 8 OUT PLUS — F Series

Device IO08F01KNX is a DIN rail EIB / KNX actuators with 8 relay outputs that can be configured as:

- 8 outputs for light / load control
- 8 channels for valve in PWM (solenoid actuators)
- 4 channels for roller shutter / venetian control
- 4 channels for 3-point valve control
- 2 fan coil actuators 2-pipes

It is also possible to combine 2 or 3 relays with logic interlock for 4-pipe / 3-speed fan coil control or combine groups of relays (up to 8) for special function using logic interlock .

The device also includes 8 inputs that can be connected to pushbuttons, switches, or be configured as outputs to activate individual signaling LEDs (eelectron code LD00A01ACC / LD00A11ACC) and can be used for on / off, dimming, shutters or venetian blinds / scenarios, sequences, step-by-step commands, etc. 4 inputs (of the 8) are configurable as analogue for the connection of NTC temperature probes (see probes eelectron code TS00A01ACC / TS00B01ACC) with which to send 4 temperature measurements on the bus and manage a simple on / off controls (e.g. thermo furniture).

It is also possible to enable 2 complete thermostat modules; each thermostat module manages 2 stages with integrated PI controller for driving heating and cooling equipment, valves, 2 and 4-pipe fan coils, etc.

Version IO08F01KNX-SD includes a microSD card reader includes a microSD card with which you can save the programming of the device to be able to restore it on an identical device in order to avoid programming in field or to allow a fast restore in case of failure.



Technical Features

Mechanical data	<ul style="list-style-type: none"> • Dimensions: 4 DIN modules
Supply	<ul style="list-style-type: none"> • Via bus EIB/KNX cable: 21 ÷ 32 Vdc
Input - digital mode	<ul style="list-style-type: none"> • For free potential contacts (dry contacts) • Max. length of Connecting Cables ≤ 30 m (twisted cable)
Input - analog mode for temperature probe	<ul style="list-style-type: none"> • For NTC temperature probe eelectron code: • TS01A01ACC (range from -20°C to +100°C) • TS01B01ACC (range from -50°C to +60°C) • TS01D01ACC (range from -40°C to 125°C) • Max. length of Connecting Cable: ≤ 20 m (twisted cable)
Output rate	<ul style="list-style-type: none"> • 16 A cos φ 1 - 230 Vac • 8 A cos φ 0.6 - 230 Vac • Max current relay output: 16 A/16 AX (140 μF) • Max peak current: 165 A / 20 ms • Incandescent lamps: max 10 A • Motors e motor reduction units: max 10 A • Fluorescent lamps (max 140 μF) max 3 A (700 W) • Electronic ballast: max 6 A • LED's lamps drivers: always check that the maximum peak current drawn by led power supply is lower than maximum peak current allowed for the relay

Order Codes

IO08F01KNX
Universal Actuator 8 IN / 8 OUT Plus

IO08F01KNX-SD
Universal Actuator 8 IN / 8 OUT + SD Card

Universal Module

12 IN / 12 OUT PLUS — F Series

Device IO12F01KNX is a DIN rail EIB / KNX actuators with 12 relay outputs that can be configured as:

- 12 outputs for light / load control
- 12 channels for valve in PWM (solenoid actuators)
- 6 channels for roller shutter / venetian control
- 6 channels for 3-point valve control
- 3 fan coil actuators 2-pipes / 2 fan coil actuators 4-pipes

The device also includes 12 inputs that can be connected to pushbuttons, switches, or be configured as outputs to activate individual signaling LEDs (eelectron code LD00A01ACC / LD00A11ACC) and can be used for on / off, dimming, shutters or venetian blinds / scenarios, sequences, step-by-step commands, etc. 4 inputs (of the 12) are configurable as analogue for the connection of NTC temperature probes (see probes eelectron code TS00A01ACC / TS00B01ACC) with which to send 4 temperature measurements on the bus and manage a simple on / off controls (e.g. thermo furniture).

It is also possible to enable 3 complete thermostat modules; each thermostat module manages 2 stages with integrated PI controller for driving heating and cooling equipment, valves, 2 and 4-pipe fan coils, etc.

Version IO12F01KNX-SD includes a microSD card reader includes a microSD card with which you can save the programming of the device to be able to restore it on an identical device in order to avoid programming in field or to allow a fast restore in case of failure.

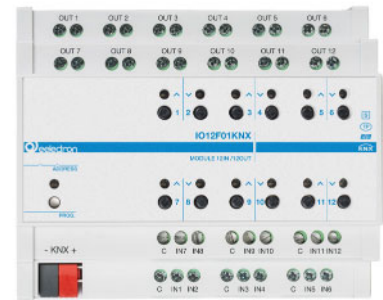

Technical Features

Mechanical data	<ul style="list-style-type: none"> • Dimensions: 6 DIN modules
Supply	<ul style="list-style-type: none"> • Via bus EIB/KNX cable: 21 ÷ 32 Vdc
Input - digital mode	<ul style="list-style-type: none"> • For free potential contacts (dry contacts) • Max. length of Connecting Cables ≤ 30 m (twisted cable)
Input - analog mode for temperature probe	<ul style="list-style-type: none"> • For NTC temperature probe eelectron code: • TS01A01ACC (range from -20°C to +100°C) • TS01B01ACC (range from -50°C to +60°C) • TS01D01ACC (range from -40°C to 125°C) • Max. length of Connecting Cable: ≤ 20 m (twisted cable)
Output rate	<ul style="list-style-type: none"> • 16 A cos φ 1 - 230 Vac • 8 A cos φ 0.6 - 230 Vac • Max current relay output: 16 A/16 AX (140 μF) • Max peak current: 165 A / 20 ms • Incandescent lamps: max 10 A • Motors e motor reduction units: max 10 A • Fluorescent lamps (max 140 μF) max 3 A (700 W) • Electronic ballast: max 6 A • LED's lamps drivers: always check that the maximum peak current drawn by led power supply is lower than maximum peak current allowed for the relay

Order Codes

IO08F01KNX
Universal Actuator 12 IN / 12 OUT Plus

IO08F01KNX-SD
Universal Actuator 12 IN / 12 OUT + SD Card

Universal Module

16 IN / 16 OUT PLUS — F Series

Device IO16F01KNX is a DIN rail EIB / KNX actuators with 16 relay outputs that can be configured as:

- 16 outputs for light / load control
- 16 channels for valve in PWM (solenoid actuators)
- 8 channels for roller shutter / venetian control
- 8 channels for 3-point valve control
- 4 fan coil actuators 2-pipes

It is also possible to combine 2 or 3 relays with logic interlock for 4-pipe / 3-speed fan coil control or combine groups of relays (up to 8) for special function using logic interlock .

The device also includes 16 inputs that can be connected to pushbuttons, switches, or be configured as outputs to activate individual signaling LEDs (eelectron code LD00A01ACC / LD00A11ACC) and can be used for on / off, dimming, shutters or venetian blinds / scenarios, sequences, step-by-step commands, etc. 4 inputs (of the 16) are configurable as analogue for the connection of NTC temperature probes (see probes eelectron code TS00A01ACC / TS00B01ACC) with which to send 4 temperature measurements on the bus and manage a simple on / off controls (e.g. thermo furniture). It is also possible to enable 2 complete thermostat modules if inputs 3 ÷ 8 and 11 ÷ 16 are not used; each thermostat module manages 2 stages with integrated PI controller for driving heating and cooling equipment, valves, 2 and 4-pipe fan coils, etc.

Version IO16F01KNX-SD includes a microSD card reader includes a microSD card reader with which you can save the programming of the device to be able to restore it on an identical device in order to avoid programming in field or to allow a fast restore in case of failure.



Technical Features

Mechanical data	<ul style="list-style-type: none"> • Dimensions: 8 DIN modules
Supply	<ul style="list-style-type: none"> • Via bus EIB/KNX cable: 21 ÷ 32 Vdc
Input - digital mode	<ul style="list-style-type: none"> • For free potential contacts (dry contacts) • Max. length of Connecting Cables ≤ 30 m (twisted cable)
Input - analog mode for temperature probe	<ul style="list-style-type: none"> • For NTC temperature probe eelectron code: • TS01A01ACC (range from -20°C to +100°C) • TS01B01ACC (range from -50°C to +60°C) • TS01D01ACC (range from -40°C to 125°C) • Max. length of Connecting Cable: ≤ 20 m (twisted cable)
Output rate	<ul style="list-style-type: none"> • 16 A cos φ 1 - 230 Vac • 8 A cos φ 0.6 - 230 Vac • Max current relay output: 16 A/16 AX (140 μF) • Max peak current: 165 A / 20 ms • Incandescent lamps: max 10 A • Motors e motor reduction units: max 10 A • Fluorescent lamps (max 140 μF) max 3 A (700 W) • Electronic ballast: max 6 A • LED's lamps drivers: always check that the maximum peak current drawn by led power supply is lower than maximum peak current allowed for the relay

Order Codes

IO16F01KNX
Universal Actuator 16 IN / 16 OUT Plus

IO16F01KNX-SD
Universal Actuator 16 IN / 16 OUT + SD Card

Module 4 Digital Inputs

4 IN — F Series

The BI04F01KNX device is equipped with 4 inputs for interfacing dry contacts, for example sensors, switch buttons, etc.

Inputs functions are: on / off control, dimmers, roller shutters and scene recall, etc.

Short and long pressure management, switching, sequences are possible. The lines can be monitored using an end of line resistor (EOL) of 1.8KΩ [1/8W] value which allows the device to manage sensors with a higher level of safety such as magnetic contacts, motion detectors.

The pulse counter function is also available for counting the pulses detectable on each input. One of the 4 inputs can be configured as analogue for the connection of NTC temperature probes (see eelectron probes code TS00A01ACC / TS00B01ACC) with which to send the temperature measurement on the bus or manage a complete thermostat module. The thermostat manages 2 stages with an integrated PI controller for controlling heating and cooling equipment, valves, 2 and 4-pipe fan coils, etc. Two of the 4 inputs can be configured as “smart sensor” for the connection of ‘plug-in sensor’ (see SM03E01ACC CO₂ - temperature, SM03E02ACC VOC - temperature - eCO₂). On the front panel there is a LED to display the status of each input.

The device integrates the “Virtual Holder Logic”; the field of application is the hotel room: through a magnetic sensor installed on the door and connected to a digital input, accurate presence information is managed. The presence detection solution can deduce the presence of people in the room using one or more dedicated sensors. It also detects an unexpected presence and is able to differentiate more behaviors.

Moreover, 10 logic blocks are available to implement simple expressions with logical or threshold operator or complex expressions with algebraic and conditional operators; It is possible to use predefined algorithms as proportional controls of temperature and humidity or dew point calculation.



Technical Features

Mechanical data	<ul style="list-style-type: none"> • Dimensions: 4 DIN modules
Supply	<ul style="list-style-type: none"> • Via bus EIB/KNX cable: 21 ÷ 32 Vdc • Auxiliary supply: 230 Vac
Input - digital mode	<ul style="list-style-type: none"> • For free potential contacts (dry contacts) • Max. length of Connecting Cables ≤ 100 m (twisted cable)
Input - analog mode for temperature probe	<p>For NTC temperature probe eelectron code:</p> <ul style="list-style-type: none"> • TS01A01ACC (range from -20°C to +100°C) • TS01B01ACC (range from -50°C to +60°C) • Max. length of Connecting Cable: ≤ 30 m (twisted cable)

Order Codes

BI04F01KNX
Din Module 4 Digital Inputs

Module 8 Digital Inputs

8 IN — F Series

The BI08F01KNX device is equipped with 8 inputs for interfacing dry contacts, for example sensors, switch buttons, etc.

Inputs functions are: on / off control, dimmers, roller shutters and scene recall, etc.

Short and long pressure management, switching, sequences are possible. The lines can be monitored using an end of line resistor (EOL) of 1.8KΩ [1/8W] value which allows the device to manage sensors with a higher level of safety such as magnetic contacts, motion detectors.

The pulse counter function is also available for counting the pulses detectable on each input. One of the 8 inputs can be configured as analogue for the connection of NTC temperature probes (see eelectron probes code TS00A01ACC / TS00B01ACC) with which to send the temperature measurement on the bus or manage a complete thermostat module. The thermostat manages 2 stages with an integrated PI controller for controlling heating and cooling equipment, valves, 2 and 4-pipe fan coils, etc. Two of the 4 inputs can be configured as “smart sensor” for the connection of ‘plug-in sensor’ (see SM03E01ACC CO₂ - temperature, SM03E02ACC VOC - temperature - eCO₂). On the front panel there is a LED to display the status of each input.

The device integrates the “Virtual Holder Logic”; the field of application is the hotel room: through a magnetic sensor installed on the door and connected to a digital input, accurate presence information is managed. The presence detection solution can deduce the presence of people in the room using one or more dedicated sensors. It also detects an unexpected presence and is able to differentiate more behaviors.

Moreover, 10 logic blocks are available to implement simple expressions with logical or threshold operator or complex expressions with algebraic and conditional operators; It is possible to use predefined algorithms as proportional controls of temperature and humidity or dew point calculation.



Technical Features

Mechanical data	<ul style="list-style-type: none"> • Dimensions: 4 DIN modules
Supply	<ul style="list-style-type: none"> • Via bus EIB/KNX cable: 21 ÷ 32 Vdc • Auxiliary supply: 230 Vac
Input - digital mode	<ul style="list-style-type: none"> • For free potential contacts (dry contacts) • Max. length of Connecting Cables ≤ 100 m (twisted cable)
Input - analog mode for temperature probe	<p>For NTC temperature probe eelectron code:</p> <ul style="list-style-type: none"> • TS01A01ACC (range from -20°C to +100°C) • TS01B01ACC (range from -50°C to +60°C) • Max. length of Connecting Cable: ≤ 30 m (twisted cable)

Order Codes

BI08F01KNX
Din Module 8 Digital Inputs

Module 16 Digital Inputs

16 IN – F Series

Device 16 Input Module BI16F01KNX is an EIB/ KNX DIN rail mounting device useful to interface commands (e.g. push buttons) for any kind of applications. The device is equipped with 16 binary inputs. Inputs can be connected to conventional switching devices (potential free), e.g. push buttons, switches, floating contacts, for switching functions with pulse edge evaluation (e.g. rising or falling edge, toggle...).

Inputs can be configured with ETS SW as output to drive Leds. Inputs can be used for on/off commands, dimming, shutter control, scene recall and control; outputs include switching function, scene recall and control logic function.

Device is equipped with KNX communication interface.

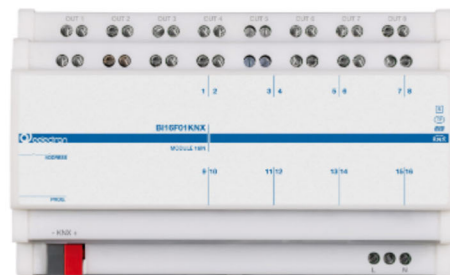

Technical Features	
Mechanical data	<ul style="list-style-type: none"> • Dimensions: 8 DIN modules
Supply	<ul style="list-style-type: none"> • Via bus EIB/KNX cable: 21 ÷ 32 Vdc • Auxiliary supply: 230 Vac
Input - digital mode	<ul style="list-style-type: none"> • For free potential contacts (dry contacts) • Max. length of Connecting Cables ≤ 100 m (twisted cable)

Order Codes
<p>BI16F01KNX Din Module 16 Digital Inputs</p>

Universal Module

4 OUT - PLUS — F Series

Device BO04F01KNX is a DIN rail EIB / KNX actuators with 4 relay outputs that can be configured as:

- 4 outputs for light / load control
- 4 channels for valve in PWM (solenoid actuators)
- 2 channels for roller shutter / venetian control
- 2 channels for 3-point valve control
- 1 fan coil actuators 2-pipes

Version BO04F01KNX-SD includes a microSD card reader with which you can save the programming of the device to be able to restore it on an identical device in order to avoid programming in field or to allow a fast restore in case of failure.



Technical Features

Mechanical data	<ul style="list-style-type: none"> • Dimensions: 4 DIN modules
Supply	<ul style="list-style-type: none"> • Via bus EIB/KNX cable: 21 ÷ 32 Vdc
Output rate	<ul style="list-style-type: none"> • 16 A cos φ 1 - 230 Vac • 8 A cos φ 0,6 - 230 Vac • Max current relay output: 16 A/16 AX (140 μF) • Max peak current: 165 A / 20 ms • Incandescent lamps: max 10 A • Motors e motor reduction units: max 10 A • Fluorescent lamps (max 140 μF) max 3 A (700 W) • Electronic ballast: max 6 A • LED's lamps drivers: always check that the maximum peak current drawn by led power supply is lower than maximum peak current allowed for the relay

Order Codes

- BO04F01KNX**
Universal Actuator 4 OUT Plus
- BO04F01KNX - SD**
Universal Actuator 4 OUT + SD Card

Universal Module

8 OUT - PLUS — F Series

Device BO08F01KNX is a DIN rail EIB / KNX actuators with 8 relay outputs that can be configured as:

- 8 outputs for light / load control
- 8 channels for valve in PWM (solenoid actuators)
- 4 channels for roller shutter / venetian control
- 4 channels for 3-point valve control
- 2 fan coil actuators 2-pipes

It is also possible to combine 2 or 3 relays with logic interlock for 4-pipe / 3-speed fan coil control or combine groups of relays (up to 8) for special function using logic interlock .

Version BO08F01KNX-SD includes a microSD card reader with which you can save the programming of the device to be able to restore it on an identical device in order to avoid programming in field or to allow a fast restore in case of failure.

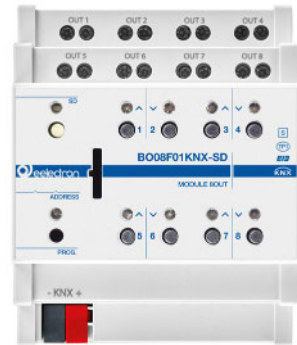

Technical Features

Mechanical data	<ul style="list-style-type: none"> • Dimensions: 4 DIN modules
Supply	<ul style="list-style-type: none"> • Via bus EIB/KNX cable: 21 ÷ 32 Vdc
Output rate	<ul style="list-style-type: none"> • 16 A cos φ 1 - 230 Vac • 8 A cos φ 0,6 - 230 Vac • Max current relay output: 16 A/16 AX (140 μF) • Max peak current: 165 A / 20 ms • Incandescent lamps: max 10 A • Motors e motor reduction units: max 10 A • Fluorescent lamps (max 140 μF) max 3 A (700 W) • Electronic ballast: max 6 A • LED's lamps drivers: always check that the maximum peak current drawn by led power supply is lower than maximum peak current allowed for the relay

Order Codes

- BO08F01KNX**
Universal Actuator 8 OUT Plus
- BO08F01KNX - SD**
Universal Actuator 8 OUT + SD Card

Universal Module

12 OUT - PLUS — F Series

Device BO12F01KNX is a DIN rail EIB / KNX actuators with 16 relay outputs that can be configured as:

- 12 outputs for light / load control
- 12 channels for valve in PWM (solenoid actuators)
- 6 channels for roller shutter / venetian control
- 6 channels for 3-point valve control
- 3 fan coil actuators 2-pipes / 2 fan coil actuators 4-pipes

It is also possible to combine 2 or 3 relays with logic interlock for 4-pipe / 3-speed fan coil control or combine groups of relays (up to 6) for special function using logic interlock.

Version BO12F01KNX-SD includes a microSD Card reader includes a microSD card reader with which you can save the programming of the device to be able to restore it on an identical device in order to avoid programming in field or to allow a fast restore in case of failure.



Technical Features

Mechanical data	<ul style="list-style-type: none"> • Dimensions: 6 DIN modules
Supply	<ul style="list-style-type: none"> • Via bus EIB/KNX cable: 21 ÷ 32 Vdc
Output rate	<ul style="list-style-type: none"> • 16 A cos φ 1 - 230 Vac • 8 A cos φ 0,6 - 230 Vac • Max current relay output: 16 A/16 AX (140 μF) • Max peak current: 165 A / 20 ms • Incandescent lamps: max 10 A • Motors e motor reduction units: max 10 A • Fluorescent lamps (max 140 μF) max 3 A (700 W) • Electronic ballast: max 6 A • LED's lamps drivers: always check that the maximum peak current drawn by led power supply is lower than maximum peak current allowed for the relay

Order Codes

BO12F01KNX
Universal Actuator 12 OUT Plus

BO12F01KNX - SD
Universal Actuator 12 OUT + SD Card

Universal Module

16 OUT - PLUS — F Series

Device BO16F01KNX is a DIN rail EIB / KNX actuators with 16 relay outputs that can be configured as:

- 16 outputs for light / load control
- 16 channels for valve in PWM (solenoid actuators)
- 8 channels for roller shutter / venetian control
- 8 channels for 3-point valve control
- 4 fan coil actuators 2-pipes

It is also possible to combine 2 or 3 relays with logic interlock for 4-pipe / 3-speed fan coil control or combine groups of relays (up to 8) for special function using logic interlock .

Version BO16F01KNX-SD includes a microSD Card reader includes a microSD card reader with which you can save the programming of the device to be able to restore it on an identical device in order to avoid programming in field or to allow a fast restore in case of failure.



Technical Features

Mechanical data	<ul style="list-style-type: none"> • Dimensions: 8 DIN modules
Supply	<ul style="list-style-type: none"> • Via bus EIB/KNX cable: 21 ÷ 32 Vdc
Output rate	<ul style="list-style-type: none"> • 16 A cos φ 1 - 230 Vac • 8 A cos φ 0,6 - 230 Vac • Max current relay output: 16 A/16 AX (140 μF) • Max peak current: 165 A / 20 ms • Incandescent lamps: max 10 A • Motors e motor reduction units: max 10 A • Fluorescent lamps (max 140 μF) max 3 A (700 W) • Electronic ballast: max 6 A • LED's lamps drivers: always check that the maximum peak current drawn by led power supply is lower than maximum peak current allowed for the relay

Order Codes

- BO16F01KNX**
Universal Actuator 16 OUT Plus
- BO16F01KNX - SD**
Universal Actuator 16 OUT + SD Card

Universal Module

24 OUT - PLUS — F Series

Device BO24F01KNX is a DIN rail EIB / KNX actuators with 16 relay outputs that can be configured as:

- 24 outputs for light / load control
- 24 channels for valve in PWM (solenoid actuators)
- 12 channels for roller shutter / venetian control
- 12 channels for 3-point valve control
- 6 fan coil actuators 2-pipes / 4 fan coil actuators 4-pipes

It is also possible to combine 3,4 or 5 relays with logic interlock for 4-pipe / 3-speed fan coil control or combine groups of relays (up to 6) for special function using logic interlock .

Version BO24F01KNX-SD includes a microSD Card reader includes a microSD card reader with which you can save the programming of the device to be able to restore it on an identical device in order to avoid programming in field or to allow a fast restore in case of failure.

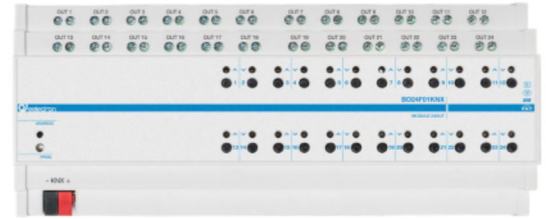

Technical Features

Mechanical data	<ul style="list-style-type: none"> • Dimensions: 12 DIN modules
Supply	<ul style="list-style-type: none"> • Via bus EIB/KNX cable: 21 ÷ 32 Vdc
Output rate	<ul style="list-style-type: none"> • 16 A cos φ 1 - 230 Vac • 8 A cos φ 0.6 - 230 Vac • Max current relay output: 16 A/16 AX (140 μF) • Max peak current: 165 A / 20 ms • Incandescent lamps: max 10 A • Motors e motor reduction units: max 10 A • Fluorescent lamps (max 140 μF) max 3 A (700 W) • Electronic ballast: max 6 A • LED's lamps drivers: always check that the maximum peak current drawn by led power supply is lower than maximum peak current allowed for the relay

Order Codes

- BO24F01KNX**
Universal Actuator 12 OUT Plus
- BO24F01KNX - SD**
Universal Actuator 12 OUT + SD Card

Universal Module

4 OUT — K Series

The device BO04K01KNX is a DIN actuator with 16A – 230 V AC relay outputs for controlling loads or shutters and blinds, it has 4 relay outputs and they can be configured in different ways:

- Every single output configured independently to control lights or generic loads
- Outputs configured in pairs to manage shutters, blinds, etc. ... (equipped with mechanical end position)

8 logic blocks are available to implement simple expressions with logical or threshold operator or complex expressions with algebraic and conditional operators Device is equipped with KNX communication interface.



Technical Features

Mechanical data	<ul style="list-style-type: none"> • Dimensions: 4 DIN modules
Supply	<ul style="list-style-type: none"> • Via bus EIB/KNX cable: 21 ÷ 32 Vdc
Output rate	<ul style="list-style-type: none"> • 16 A cos φ 1 - 230 Vac • 8 A cos φ 0.6 - 230 Vac • Max current relay output: 16 A cos φ 1 - 250 Vac • Max peak current: 117 A (TV-8 rating) • Incandescent lamps: max 5 A • Motors e motor reduction units: max 3 A • Tungsten: max 8 A • Electronic ballast: max 8 A • LED's lamps drivers: always check that the maximum peak current drawn by led power supply is lower than maximum peak current allowed for the relay

Order Codes

BO04K01KNX
Universal Actuator 4 OUT

Universal Module

8 OUT — K Series

The device BO08K01KNX is a DIN actuator with 16A – 230 V AC relay outputs for controlling loads or shutters and blinds. It has 8 relay outputs and they can be configured in different ways:

- Every single output configured independently to control lights or generic loads
- Outputs configured in pairs to manage shutters, blinds, etc. ... (equipped with mechanical end position)

8 logic blocks are available to implement simple expressions with logical or threshold operator or complex expressions with algebraic and conditional operators Device is equipped with KNX communication interface



Technical Features

Mechanical data	<ul style="list-style-type: none"> • Dimensions: 6 DIN modules
Supply	<ul style="list-style-type: none"> • Via bus EIB/KNX cable: 21 ÷ 32 Vdc
Output rate	<ul style="list-style-type: none"> • 16 A cos φ 1 - 230 Vac • 8 A cos φ 0.6 - 230 Vac • Max current relay output: 16 A cos φ 1 - 250 Vac • Max peak current: 117 A (TV-8 rating) • Incandescent lamps: max 5 A • Motors e motor reduction units: max 3 A • Tungsten: max 8 A • Electronic ballast: max 8 A • LED's lamps drivers: always check that the maximum peak current drawn by led power supply is lower than maximum peak current allowed for the relay

Order Codes

BO08K01KNX
Universal Actuator 8 OUT

Universal Module

12 OUT — K Series

The device BO12K01KNX is a DIN actuator with 16A – 230 V AC relay outputs for controlling loads or shutters and blinds. It has 12 relay outputs and they can be configured in different ways:

- Every single output configured independently to control lights or generic loads
- Outputs configured in pairs to manage shutters, blinds, etc. ... (equipped with mechanical end position)

8 logic blocks are available to implement simple expressions with logical or threshold operator or complex expressions with algebraic and conditional operators Device is equipped with KNX communication interface



Technical Features

Mechanical data	<ul style="list-style-type: none"> • Dimensions: 8 DIN modules
Supply	<ul style="list-style-type: none"> • Via bus EIB/KNX cable: 21 ÷ 32 Vdc
Output rate	<ul style="list-style-type: none"> • 16 A cos φ 1 - 230 Vac • 8 A cos φ 0.6 - 230 Vac • Max current relay output: 16 A cos φ 1 - 250 Vac • Max peak current: 117 A (TV-8 rating) • Incandescent lamps: max 5 A • Motors e motor reduction units: max 3 A • Tungsten: max 8 A • Electronic ballast: max 8 A • LED's lamps drivers: always check that the maximum peak current drawn by led power supply is lower than maximum peak current allowed for the relay

Order Codes

BO12K01KNX
Universal Actuator 12 OUT

Universal Dimmer

1 CHANNEL 700 W - MASTER AND SLAVE

DM01D01KNX is a KNX power dimmer 1-channel acting as a Master Dimmer to which you can connect up to two Slave Modules (cod. DM01D01ACC) with identical characteristics to the Master power dimmer and connected to it by a local two wires bus.

Dimmer DM01D01KNX can be used in one of the following configurations:

Trailing Edge: The dimmer turns off part of the final part of the waveform of the input voltage resulting in reduced lamp output. This load regulation is used for resistive or capacitive loads (typically halogen lamps with electronic transformer or incandescent lamps).

Leading Edge: The dimmer turns off part of the initial part of the waveform of the input voltage, resulting in reduced lamp output. This load regulation is used for inductive loads (typically ferromagnetic transformers or toroidal).

The three channels are independent and can therefore operate on different phases of the same three phase systems respecting the limit of 230 Vac between phase and neutral.



Technical Features

Mechanical data	<ul style="list-style-type: none"> • Dimensions: 4 DIN modules
Supply	<ul style="list-style-type: none"> • Via bus EIB/KNX cable: 21 ÷ 32 Vdc • Input power supply: 230 Vac 50/60 Hz
Connections	<ul style="list-style-type: none"> • Power supply & load cable: max 2,5 mm² • Local bus length: max 2 m between 2 modules
Output rate	<ul style="list-style-type: none"> • Incandescent or halogen lamps: 20-700 W • Ferromagnetic transformer 20-700 VA • Electronic transformer: 20-700 VA • Dimmable LED Lamps: Max 160 W • Compact fluorescent lamps (ESL/CFL): Max 160 W

Order Codes

DM01D01KNX
Universal Dimmer 1 Channel 700 W
Master

DM01D01ACC
Universal Dimmer 1 Channel 700 W
Slave

Universal Dimmer

2 CHANNELS X 300 W

DM02A02KNX is a KNX universal power dimmer 2 channels with automatic identification of load type and with settable parameters to optimize control of different lamps like LED, incandescent and halogen, CFL dimmable lights, low voltage lamps with electronic or ferromagnetic transformer.

The 2 channels can be used independently or combined in pair to drive higher power loads; always respect the maximum power values indicated in the table of this instruction sheet and check in the handbook how to configure the outputs as combined in ETS. To define the maximum load and in particular the maximum number of lamps that can be connected, the DimmerLoadTester software is available; with it is possible to analyze the peak absorption of a single lamp and calculate the maximum number of lamps that can be connected.

Load control is possible in leading and trailing edge.



Technical Features

Mechanical data	• Dimensions: 4 DIN modules		
Supply	• Via bus EIB/KNX cable: 21 ÷ 32 Vdc • Input power supply: 230 Vac 50/60 Hz		
Output rate		Single	Paired
	Incandescent or halogen lamps (230 V~ 50/60 Hz) 300 W 600 W RC LIN	300 W	600 W
	Ferromagnetic transformer (Halogen lamps 12/24 V ~ 50/60 Hz) 200 VA 400 VA L (1) LIN	200 VA	400 VA
	Electronic transformers (Halogen lamps 12/24 V ~ 50/60 Hz)	60 VA	100 VA
	Dimmable LED lamps (230 V~ 50/60 Hz) - L	60 W	100 W
	Dimmable LED lamps (230 V~ 50/60 Hz) - RC	120 W	200 W
	Compact Fluorescent Lamps (ESL/CFL)	60 W	100 W

Order Codes

DM02A02KNX
Universal DIN Dimmer 2 Channels x 300 W

Universal Dimmer

4 CHANNELS X 300 W

DM04A02KNX is a KNX universal power dimmer 4-channels with automatic identification of load type and with settable parameters to optimize control of different lamps like LED, incandescent and halogen, CFL dimmable lights, low voltage lamps with electronic or ferromagnetic transformer.

The 4 channels can be used independently or combined in pair (1+2 and 3+4) to drive higher power loads; always respect the maximum power values indicated in the table of this instruction sheet and check in the handbook how to configure the outputs as combined in ETS. To define the maximum load and in particular the maximum number of lamps that can be connected, the DimmerLoadTester software is available; with it is possible to analyze the peak absorption of a single lamp and calculate the maximum number of lamps that can be connected.

Load control is possible in leading and trailing edge.



Technical Features

Mechanical data	• Dimensions: 8 DIN modules		
Supply	<ul style="list-style-type: none"> • Via bus EIB/KNX cable: 21 ÷ 32 Vdc • Input power supply: 230 Vac 50/60 Hz 		
Output rate		Single	Paired
	Incandescent or halogen lamps (230 V~ 50/60 Hz) 300 W 600 W RC LIN	300 W	600 W
	Ferromagnetic transformer (Halogen lamps 12/24 V ~ 50/60 Hz) 200 VA 400 VA L (1) LIN	200 VA	400 VA
	Electronic transformers (Halogen lamps 12/24 V ~ 50/60 Hz)	60 VA	100 VA
	Dimmable LED lamps (230 V~ 50/60 Hz) - L	60 W	100 W
	Dimmable LED lamps (230 V~ 50/60 Hz) - RC	120 W	200 W
	Compact Fluorescent Lamps (ESL/CFL)	60 W	100 W

Order Codes

DM04A02KNX
 Universal DIN Dimmer 4 Channels x 300 W

Led Dimmer

CV LED DIMMER 4 CHANNELS KNX

DL04A01KNX is a dimming actuator for LED in DC with constant voltage (CV). The device allows to drive 4 independent channels or 1 RGB channel and 1 single color channel or 1 channel RGBW. Module can be powered from 12 to 48 Vdc and consequently can manage the outputs (LED strips) with voltage from 12 to 48 Vdc. The device includes a 16 A relay, suitable for switching capacitive loads, that allows a complete shutdown of the external power supply when all loads are switched off (for example at night) ensuring the maximization of the energy saving.

Available functions include block, logic, scenes, color sequences, etc.

Device is equipped with KNX communication interface.

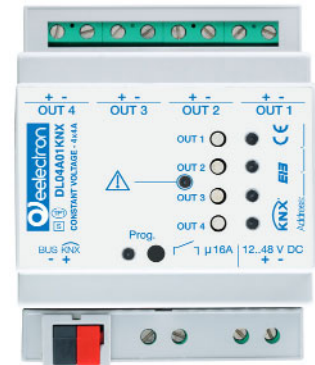

Technical Features

Mechanical data	<ul style="list-style-type: none"> • Dimensions: 4 DIN modules
Supply	<ul style="list-style-type: none"> • From KNX bus 21 ÷ 32 Vdc SELV • AUX input to supply LED's : 12 ÷ 48 Vdc ± 10% • Current Consumption ≤16 A
Output rate	<ul style="list-style-type: none"> • Max output for each channel: 4 A • PWM frequency: 200 / 260 / 400 Hz
Hardware protection	<ul style="list-style-type: none"> • Over current • Over temperature • Reverse Polarity

Order Codes

DL04A01KNX
Led Dimmer CH 4 Channels KNX

Dimmer

4 CHANNELS X 1-10 V

DM04D01KNX is a KNX 4 channel dimmer with switching and brightness setting for lamps with operating devices with 1-10 V interface.

- Manual switching of the relays is independent of the Bus
- Switching of capacitive loads and the resulting high switchon currents
- Flexible assignment of control inputs to switching outputs, e.g. to control RGBW lamps
- Operation of the switching outputs as a switching actuator
- Connection of various external conductors
- No additional power supply necessary
- Feedback of switching state and brightness value
- Switch position display
- Burnin function for fluorescent lamps
- Switchon and dimming behaviour can be set
- Time functions: switchon delay, switchoff, delay, staircase lighting timer with run-on time
- Integration into light scenes
- Operating hours counter



Technical Features

Mechanical data	<ul style="list-style-type: none"> • Dimensions: 4 DIN modules
Supply	<ul style="list-style-type: none"> • Via bus EIB/KNX cable: 21 ÷ 32 Vdc
Output rate	<ul style="list-style-type: none"> • Fluorescent lamps 16 AX • Minimum switching current 100 mA • Switch on current 150 µs 600 A • Switch on current 600 µs 300 A • Ohmic load 3680 W • Capacitive load 16 A / 200 µF • Incandescent lamps 3680 W • HV halogen lamps 3680 W • LV halogen lamps with inductive transformer 2000 VA • LV halogen lamps with Tronic transformer 2500 W • Fluorescent lamps T5/T8 uncompensated 3680 W • Parallel compensated 2500 W / 200 µF • Twinlamp circuit 3680 W / 200 µF • Compact fluorescent lamps uncompensated 3680 W • Parallel compensated 2500 W / 200 µF • Mercury vapour lamps uncompensated 3680 W • Parallel compensated 3680 W / 200 µF

Order Codes

DM04D01KNX
4 Channels x 1-10 V

Valves / Loads Actuator

8 IN / 4 + 4 OUT

The HA88B01KNX device is EIB/KNX DIN rail actuator with 16 A - 230 Vac relay outputs; the device also include inputs for dry contacts (potential-free).

The outputs can be configured as:

- 4 outputs for light / load control
- 8 (4) channels for valve control in ON / OFF or PWM
- 4 (2) channels for 3-points valve control
- 1 fan coil actuators 2-pipes with 3 speeds
- 1 fan coil actuators 4-pipes with 3 speeds

Inputs from 1 to 4 can be configured as outputs to activate single signaling LEDs (see eelectron leds code LD00A01ACC / LD00A11ACC) or can be configured as analogue inputs for the connection of NTC temperature probes (see eelectron probes code TS00A01ACC / TS00B01ACC) with which to send 4 temperature measurements on the bus or to manage 4 complete thermostat modules.

Each thermostat module manages 2 stages with an integrated PI controller for controlling heating and cooling equipment, valves, 2 and 4 pipe fan coils, etc. Additional 4 thermostat modules are available in the device for a total of 8. Moreover, 4 logic blocks are available to implement simple expressions with logical/threshold operator or complex expressions with algebraic and conditional operators; It's possible to use predefined algorithms as proportional controls of temperature and humidity or dew point calculation. Device is equipped with KNX communication interface and is intended for installation on DIN rail in LV distribution cabinets.



Technical Features

Mechanical data	<ul style="list-style-type: none"> • Dimensions: 4 DIN modules
Supply	<ul style="list-style-type: none"> • Via bus EIB/KNX cable: 21 ÷ 32 Vdc
Input - digital mode	<ul style="list-style-type: none"> • For free potential contacts (dry contacts) • Max. length of Connecting Cables ≤ 30 m (twisted cable)
Input - analog mode for temperature probe	<p>For NTC temperature probe eelectron code:</p> <ul style="list-style-type: none"> • TS01A01ACC (range from -20°C to +100°C) • TS01B01ACC (range from -50°C to +60°C) • TS01D01ACC (range from -40°C to 125°C) • Max. length of Connecting Cable: ≤ 30 m (twisted cable)
Output rate - triac	<ul style="list-style-type: none"> • 24 ÷ 230 Vac 50/60 Hz
Output rate - relay	<ul style="list-style-type: none"> • 16 A cos φ 1 - 230 Vac • 8 A cos φ 0.6 - 230 Vac • Max current relay output: 16 A/16 AX (140 μF) • Max peak current: 165 A / 20 ms • Incandescent lamps: max 10 A • Motors e motor reduction units: max 10 A • Fluorescent lamps (max 140 μF) max 3A (700 W) • Electronic ballast: max 6 A • LED's lamps drivers: always check that the maximum peak current drawn by led power supply is lower than maximum peak current allowed for the relay

Order Codes

HA88B01KNX
Valves / Loads Actuator
8 IN / 4 + 4 OUT

Fan Coil Controller

Universal Fancoil Controller 0-10 V

The TC57A01KNX device is a DIN rail EIB / KNX actuator for fan coil control with 3 x 0-10 V outputs and 3x16 A relays. Two 0-10 V outputs are dedicated to proportional valves, variable fan speeds can be controlled with a third 0-10 V output or with 3 relays on board. If the 3 relays are not used for speeds, they can switch lights or other loads. An analogue input is also available for reading 0-10 V or 4-20 mA signals in order to interface temperature, humidity or CO₂ probes; the third 0-10 V output can also be configured as analog input. Five digital inputs are available for dry contact reading for the connection of buttons, window contacts, alarms; Two inputs can be connected to NTC temperature probes (eelectron codes TS00A01ACC and TS00B01ACC).

The internal logic can manage a 2-4 tube fan coil with an internal 2-stage PI algorithm. A sophisticated parameterization allows its use in modern systems that require a differentiation of the behaviour between speed and valves (independent regulation differentials), ventilation to avoid air stratification, logics for efficient maintenance of comfort and energy saving.



Technical Features

Mechanical data	<ul style="list-style-type: none"> Dimensions: 6 DIN modules
Supply	<ul style="list-style-type: none"> Via bus EIB/KNX cable: 21 ÷ 32 Vdc
Input - digital mode	<ul style="list-style-type: none"> For free potential contacts (dry contacts) Max. length of Connecting Cables ≤ 30 m (twisted cable)
Input - analog mode for temperature probe	For NTC temperature probe eelectron code: <ul style="list-style-type: none"> TS01A01ACC (range from -20°C to +100°C) TS01B01ACC (range from -50°C to +60°C) TS01D01ACC (range from -40°C to 125°C) Max. length of Connecting Cable: ≤ 30m (twisted cable)
Input - analog mode for general purpose	<ul style="list-style-type: none"> 0 - 10 V / 4 - 20 mA
Output rate - relay	<ul style="list-style-type: none"> 16 A cos φ 1 - 230 Vac 8 A cos φ 0,6 - 230 Vac Resistive load: max 16 A Incandescent lamps: max 8 A Fluorescent lamps (max 140 μF) max 3 A (700 W)
Output rate - analog mode for general purpose	<ul style="list-style-type: none"> 0 - 10 V, max 2.5 mA

Order Codes

TC57A01KNX
 Universal Fan Coil Controller
 3 X 0-10 V | 5 IN - 3 OUT

Fan Coil Controller Plus

Universal Fancoil Controller Plus 4 X 0-10 V | 5 IN - 3 OUT

The TC57B01KNX device is a DIN rail EIB / KNX actuator for fan coil control with 4 x 0-10 V outputs and 3x16 A relays. Two 0-10 V outputs are dedicated to proportional valves, variable fan speeds can be controlled with a third 0-10 V output or with 3 relays on board. If the 3 relays are not used for speeds, they can switch lights or other loads. An analogue input (IN 5) is also available for reading 0-10 V or 4-20 mA signals in order to interface temperature, humidity or CO₂ probes; the fourth 0-10 V output can also be configured as analog input. Five digital inputs are available for dry contact reading for the connection of buttons, window contacts, alarms; Two inputs can be connected to NTC temperature probes (eelectron codes TS00A01ACC and TS00B01ACC).

The internal logic can manage a 2-4 tube fan coil with an internal 2-stage PI algorithm. A sophisticated parameterization allows its use in modern systems that require a differentiation of the behaviour between speed and valves (independent regulation differentials), ventilation to avoid air stratification, logics for efficient maintenance of comfort and energy saving.



Technical Features

Mechanical data	<ul style="list-style-type: none"> • Dimensions: 6 DIN modules
Supply	<ul style="list-style-type: none"> • Via bus EIB/KNX cable: 21 ÷ 32 Vdc
Input - digital mode	<ul style="list-style-type: none"> • For free potential contacts (dry contacts) • Max. length of Connecting Cables ≤ 30 m (twisted cable)
Input - analog mode for temperature probe	For NTC temperature probe eelectron code: <ul style="list-style-type: none"> • TS01A01ACC (range from -20°C to +100°C) • TS01B01ACC (range from -50°C to +60°C) • TS01D01ACC (range from -40°C to 125°C) • Max. length of Connecting Cable: ≤ 30m (twisted cable)
Input - analog mode for general purpose	<ul style="list-style-type: none"> • 0 - 10 V / 4 - 20 mA
Output rate - relay	<ul style="list-style-type: none"> • 16 A cos φ 1 - 230 Vac • 8 A cos φ 0.6 - 230 Vac • Resistive load: max 16 A • Incandescent lamps: max 8 A • Fluorescent lamps (max 140 µF) max 3 A (700 W)
Output rate - analog mode for general purpose	<ul style="list-style-type: none"> • 0 - 10 V, max 2.5 mA

Order Codes

TC57B01KNX
 Universal Fan Coil Controller Plus
 4 X 0-10 V | 5 IN - 3 OUT

Heating Actuator

4 IN / 4 OUT

The HA04A01KNX device is a EIB/KNX DIN rail actuators for electrothermal valves with 4 Triac outputs at $24 \div 230$ Vac; the devices include 4 inputs for dry (potential-free) contacts. The outputs can be configured as:

- 4 channels for valve control in ON / OFF or PWM
- 2 channels for 3-points valve control

Inputs can be connected to buttons or switches (potential-free) and can be used for on / off commands, dimming, shutters or blinds / scenarios, sequences, step commands, etc. Inputs from 1 to 4 can be configured as outputs to activate single signalling LEDs (see eelectron leds code LD00A01ACC / LD00A11ACC) or can be configured as analogue inputs for the connection of NTC temperature probes (see eelectron probes code TS00A01ACC / TS00B01ACC) with which to send 4 temperature measurements on the bus or to manage 4 complete thermostat modules. Each thermostat module manages 2 stages with an integrated PI controller for controlling heating and cooling equipment, valves, 2 and 4 pipe fan coils, etc. Additional 4 thermostat modules are available in the device for a total of 8. Moreover, 8 logic blocks are available to implement simple expressions with logical/threshold operator or complex expressions with algebraic and conditional operators; It's possible to use predefined algorithms as proportional controls of temperature and humidity or dew point calculation.

Device is equipped with KNX communication interface and is intended for installation on DIN rail in LV distribution cabinets.



Technical Features

Mechanical data	<ul style="list-style-type: none"> • Dimensions: 4 DIN Modules
Supply	<ul style="list-style-type: none"> • Via bus EIB/KNX cable: $21 \div 32$ Vdc
Input - digital mode	<ul style="list-style-type: none"> • For free potential contacts (dry contacts) • Max. length of Connecting Cables ≤ 30 m (twisted cable)
Input - analog mode for temperature probe	<p>For NTC temperature probe eelectron code:</p> <ul style="list-style-type: none"> • TS01A01ACC (range from -20°C to $+100^{\circ}\text{C}$) • TS01B01ACC (range from -50°C to $+60^{\circ}\text{C}$) • TS01D01ACC (range from -40°C to 125°C) • Max. length of Connecting Cable: ≤ 30 m (twisted cable)
Output rate - triac	<ul style="list-style-type: none"> • $24 \div 230$ Vac 50/60 Hz

Order Codes

HA04A01KNX

Actuator for Electrothermal Valves 4 Inputs / 4 Outputs

Heating Actuator

8 IN / 8 OUT

The HA08A01KNX device is a EIB/KNX DIN rail actuators for electrothermal valves with 8 Triac outputs at 24 ÷ 230 Vac; the devices include 8 inputs for dry (potential-free) contacts. The outputs can be configured as:

- 8 channels for valve control in ON / OFF or PWM
- 4 channels for 3-points valve control

Inputs can be connected to buttons or switches (potential-free) and can be used for on / off commands, dimming, shutters or blinds / scenarios, sequences, step commands, etc. Inputs from 1 to 4 can be configured as outputs to activate single signaling LEDs (see eelectron leds code LD00A01ACC / LD00A11ACC) or can be configured as analogue inputs for the connection of NTC temperature probes (see eelectron probes code TS00A01ACC / TS00B01ACC) with which to send 4 temperature measurements on the bus or to manage 4 complete thermostat modules. Each thermostat module manages 2 stages with an integrated PI controller for controlling heating and cooling equipment, valves, 2 and 4 pipe fan coils, etc. Additional 4 thermostat modules are available in the device for a total of 8. Moreover, 8 logic blocks are available to implement simple expressions with logical/threshold operator or complex expressions with algebraic and conditional operators; It's possible to use predefined algorithms as proportional controls of temperature and humidity or dew point calculation.

Device is equipped with KNX communication interface and is intended for installation on DIN rail in LV distribution cabinets.



Technical Features

Mechanical data	<ul style="list-style-type: none"> • Dimensions: 4 DIN Modules
Supply	<ul style="list-style-type: none"> • Via bus EIB/KNX cable: 21 ÷ 32 Vdc
Input - digital mode	<ul style="list-style-type: none"> • For free potential contacts (dry contacts) • Max. length of Connecting Cables ≤ 30 m (twisted cable)
Input - analog mode for temperature probe	<p>For NTC temperature probe eelectron code:</p> <ul style="list-style-type: none"> • TS01A01ACC (range from -20°C to +100°C) • TS01B01ACC (range from -50°C to +60°C) • TS01D01ACC (range from -40°C to 125°C) • Max. length of Connecting Cable: ≤ 30 m (twisted cable)
Output rate - triac	<ul style="list-style-type: none"> • 24 ÷ 230 Vac 50/60 Hz

Order Codes

HA08A01KNX

Actuator for Electrothermal Valves 8 Inputs / 8 Outputs

Motorized valve drive

The device VD21A01KNX is a motorized valve drive for heating or cooling valves; Screw onto valve head. The valve drive is matched to standard valve base types using an M30×1.5 connection. In the basic setting, the valve drive fits the valve bases of make Heimeier. Adapters must be used for valve bases of other manufacturers. No function guarantee can be accepted for this.

Product characteristics

- Integrated temperature sensor
- Room temperature control
- Mechanical display of the valve stroke
- Automatic detection of the valve stroke
- An input, which can be used as a binary input
- Use in heating circuit distributor possible
- Integrated bus coupling unit
- Valve protection function



Technical Features

Mechanical data	<ul style="list-style-type: none"> • L×A×H 76×47×85 mm
Supply	<ul style="list-style-type: none"> • Via bus EIB/KNX cable: 21 ÷ 32 Vdc
Connecting cable	<ul style="list-style-type: none"> • Cable type: J-YY 1×2×0,6 mm • Cable length: 1 m • Total length per line: 30 m • Number of drives per line: 30
Connection cable, binary input/ remote sensor	<ul style="list-style-type: none"> • Poll voltage, extension inputs: approx. 3,3 V • Cable length: 10 m • Single stranded: 0,08 ... 1,5 mm² • Finely stranded without conductor sleeve: 0,08 mm² ... 1,0 mm² • Finely stranded with conductor sleeve: 0,14 mm² ... 0,5 mm²

Order Codes

VD21A01KNX
Motorized valve drive

Analog / Digital Interface

ANALOG / DIGITAL MODULE 8 INPUT - 4 LED OUTPUT - 4 THERMOSTATS

AD84C01KNX module includes 4 digital inputs to interface dry contacts and 4 analog or digital inputs for dry contacts or temperature sensors and 4 LED outputs. Digital inputs can interface sensors, traditional buttons, etc; 4 low voltage/current outputs can drive LED for synoptics panels or switches. Inputs 5 ÷ 8, set as analog inputs, can enable up to 4 temperature probes (with On/Off threshold) or 4 thermostats to control heating and cooling equipments, valves, 2 and 4 pipes fan coils; etc. Device is equipped with KNX communication interface.



Technical Features	
Mechanical data	<ul style="list-style-type: none"> • Dimensions: (H x W x D) : 43 x 36 x 24 mm
Mounting	<ul style="list-style-type: none"> • Inwall
Supply	<ul style="list-style-type: none"> • Via bus EIB/KNX cable: 21 ÷ 32 Vdc
Input - digital mode	<ul style="list-style-type: none"> • For free potential contacts (dry contacts) • Max. length of Connecting Cables ≤ 30 m (twisted cable)
Input - analog mode for temperature probe	For NTC temperature probe eelectron code: <ul style="list-style-type: none"> • TS01A01ACC (range from -20°C to +100°C) • TS01B01ACC (range from -50°C to +60°C) • TS01D01ACC (range from -40°C to 125°C) • Max. length of Connecting Cable: ≤ 30 m (twisted cable)
Output rate - LED	For LED use Eelectron LED code: <ul style="list-style-type: none"> • LD00A01ACC / LD00A11ACC) 0.5 mA / 3.3 V

Order Codes
<p>AD84C01KNX Analog / Digital Module 8 Input - 4 Led Output - 4 Thermostats</p>

Push Button Interface

2 IN - 2 OUT LED / 4 IN - 4 OUT LED / 6 IN - 2 OUT LED

The device is dedicated to interface dry contacts with 2,4 or 6 input channels, such as sensors, conventional push buttons and 2 or 4 low voltage/current output channels to drive LED signal indicator lamps. These devices are extremely compact size (only 34 x 34 x 11 mm) and can also be used in installations where the inwall space available is reduced.

The digital inputs can interface sensors, traditional buttons, etc; the 4 low-voltage output channels can drive LEDs for synoptic panels or switches. Outputs can drive low voltage LED; if possible use high-efficiency LED Eelectron cod. LD00A01ACC (blue color) or LD00A11ACC (white color).

There are also 8 blocks of logic functions freely configurable by ETS (6 blocks available on IO62D01KNX). Device is equipped with KNX communication interface.



Technical Features

Mechanical data	<ul style="list-style-type: none"> Dimensions: (H x W x D) : 34 x 34 x 11 mm
Mounting	<ul style="list-style-type: none"> Inwall
Supply	<ul style="list-style-type: none"> Via bus EIB/KNX cable: 21 ÷ 32 Vdc
Input - digital mode	<ul style="list-style-type: none"> For free potential contacts (dry contacts) Max. length of Connecting Cables ≤ 30 m (twisted cable)
Output rate - LED	For LED use Eelectron LED code: <ul style="list-style-type: none"> LD00A01ACC / LD00A11ACC 0.5 mA / 3.3 V

Order Codes

IO22D01KNX

Push Button interface inwall 2 in - 2 led out module

IO44D01KNX

Push Button interface inwall 4 in - 4 led out module

IO62D01KNX

Push Button interface inwall 6 in - 2 led out module

DALI Gateway

KNX - DALI

The DALI Gateway is an interface between a KNX installation and a DALI lighting system (Digital Addressable Lighting Interface). The DALI Gateway allows the switching and dimming of a maximum of 64 lights with a DALI operating device (e.g. electronic ballast). Up to 6 different addressing types of the DALI Gateway allow group orientated and individually-addressable control of DALI lights via KNX telegrams. This allows the integration of room-specific light controls, for example, of open-plan offices, multipurpose spaces, production facilities, training and conference rooms into the higher-level of KNX building management.

Depending on the configuration, up to 32 independent DALI groups are available for group addressing. For alternative control, these can be supplemented with 64 individually-addressable DALI device channels, as necessary. Optionally, master control of all connected DALI components is possible (broadcast). This means that there is no need to commission DALI, the lighting systems with few functions can be started up quickly and easily (simplified configuration without DALI commissioning).

The DALI Gateway is supplied completely via the mains voltage connection and makes the DALI system voltage (typically 16 Vdc) available. The device is designed for mounting on DIN rails.



Technical Features

Mechanical data	<ul style="list-style-type: none"> • Dimensions: 4 DIN modules
Supply	<ul style="list-style-type: none"> • Via bus EIB/KNX cable: 21 ÷ 32 Vdc • Auxiliary supply: 110 ÷ 240 Vac (50/60 Hz)
Output	<ul style="list-style-type: none"> • Control of up to 64 DALI devices • Automatic ECG replacement • Individual, group or central addressing • Emergency lighting management • Effect control for dynamic lighting effects or colour games • Manual operation of the DALI groups • Disabling function for each DALI group • Operating hours counter

Order Codes

IC00P01DAL
Gateway KNX/DALI

DALI Gateway

KNX - DALI

The DALI Gateway is an interface between a KNX installation and a DALI lighting system (Digital Addressable Lighting Interface). The DALI Gateway allows the switching and dimming of a maximum of 64 lights with a DALI operating device (e.g. electronic ballast). Up to 6 different addressing types of the DALI Gateway allow group orientated and individually-addressable control of DALI lights via KNX telegrams. This allows the integration of room-specific light controls, for example, of open-plan offices, multipurpose spaces, production facilities, training and conference rooms into the higher-level of KNX building management.

Depending on the configuration, up to 32 independent DALI groups are available for group addressing. For alternative control, these can be supplemented with 64 individually-addressable DALI device channels, as necessary. Optionally, master control of all connected DALI components is possible (broadcast). This means that there is no need to commission DALI, the lighting systems with few functions can be started up quickly and easily (simplified configuration without DALI commissioning).

The DALI Gateway is supplied completely via the mains voltage connection and makes the DALI system voltage (typically 16 Vdc) available. The device is designed for mounting on DIN rails.



Technical Features

Mechanical data	<ul style="list-style-type: none"> • Dimensions: 4 DIN modules
Supply	<ul style="list-style-type: none"> • Via bus EIB/KNX cable: 21 ÷ 32 Vdc • Auxiliary supply: 110 ÷ 240 Vac (50/60 Hz)
Output	<ul style="list-style-type: none"> • Control of up to 64 DALI devices • Automatic ECG replacement • Individual, group or central addressing • Emergency lighting management • Effect control for dynamic lighting effects or colour games • Manual operation of the DALI groups • Disabling function for each DALI group • Operating hours counter

Order Codes

IC00P02DAL
Gateway KNX/DALI - tunable white

DALI Gateway

KNX - DALI - 2 CHANNELS

The DALI Gateway is an interface between a KNX installation and a DALI lighting system (Digital Addressable Lighting Interface). The DALI Gateway allows the switching and dimming of a maximum of 64 lights with a DALI operating device (e.g. electronic ballast). Up to 6 different addressing types of the DALI Gateway allow group orientated and individually-addressable control of DALI lights via KNX telegrams. This allows the integration of room-specific light controls, for example, of open-plan offices, multipurpose spaces, production facilities, training and conference rooms into the higher-level of KNX building management.

Depending on the configuration, up to 32 independent DALI groups are available for group addressing. For alternative control, these can be supplemented with 64 individually-addressable DALI device channels, as necessary. Optionally, master control of all connected DALI components is possible (broadcast). This means that there is no need to commission DALI, the lighting systems with few functions can be started up quickly and easily (simplified configuration without DALI commissioning).

The DALI Gateway is supplied completely via the mains voltage connection and makes the DALI system voltage (typically 16 Vdc) available. The device is designed for mounting on DIN rails.



Technical Features

Mechanical data	<ul style="list-style-type: none"> • Dimensions: 4 DIN modules
Supply	<ul style="list-style-type: none"> • Via bus EIB/KNX cable: 21 ÷ 32 Vdc • Auxiliary supply: 110 ÷ 240 Vac (50/60 Hz)
Output	<ul style="list-style-type: none"> • Control of up to 64 DALI devices • Automatic ECG replacement • Individual, group or central addressing • Emergency lighting management* • Effect control for dynamic lighting effects or colour games • Manual operation of the DALI groups • Disabling function for each DALI group • Operating hours counter

Order Codes

IC02D01DAL
Gateway KNX DALI TW 2 Ch

DMX Gateway

KNX - DMX

Interface between KNX bus and DMX512 bus. Combines devices for building automation with control devices dedicated to lighting and special effects. One-way gateway that receives telegrams from the KNX bus and data bus to DMX512. Scenarios of all 512 channels can be configured and managed with KNX group addresses.



Technical Features

Mechanical data	<ul style="list-style-type: none"> • Dimensions: 6 DIN modules
Supply	<ul style="list-style-type: none"> • Via bus EIB/KNX cable: 21 ÷ 32 Vdc • Auxiliary supply: 9-30 Vdc, 100 mA, separated
Output	<ul style="list-style-type: none"> • DMX / RS485 bus

Order Codes

IC00B01DMX
Gateway KNX-DMX

Weather Station Plus

KNX

Measurement and evaluation of weather data: Wind speed, Wind direction, Precipitation, Brightness, Global radiation Twilight, Temperature, Relative air humidity and Air pressure

- Installation on the outside of buildings, preferable in the roof and facade area
- Operation with additional power supply Product characteristics
- Integrated GPS/GLONASS receiver for automated positioning
- Calculation of additional weather data: Absolute air humidity, chill temperature, comfort
- Function for shading control
- Integrated KNX bus coupling unit
- Measurement data acquisition and limit value monitoring
- Software logic modules for linking events
- Integrated heating



Technical Features

Mechanical data	<ul style="list-style-type: none"> • Dimensions: ØxH 130x68 mm
Supply	<ul style="list-style-type: none"> • Via bus EIB/KNX cable: 21 ÷ 32 Vdc • Auxiliary power supply: 21 ÷ 32 Vadc, Current consumption 100 ÷ 400 mA (dependent on the weather)
Degree of protection	<ul style="list-style-type: none"> • IP44

Order Codes

WS00A01KNX
Weather Station Plus KNX

KNX Basic Presence Detector

The BASIC version of Eelectron presence detectors range is suitable for ceiling mounting up to 4 m height.

Presence detection, based on a passive infrared sensor has 5 independently configurable channels with different functions that can be activated.

The device has a rear connector with 3 digital inputs that can be connected to buttons or switches free of potential and used for on / off commands, dimming, shutters or blinds / scenarios, sequences, step commands, etc. One of the 3 inputs can be configured as analogue for the connection of NTC temperature probes (see eelectron probes code TS00A01ACC / TS00B01ACC) with which to send the temperature measurement on the bus.

12 logic blocks are available to implement simple expressions with logical or threshold operator or complex expressions with algebraic and conditional operators.

The device also integrates the "Virtual Holder Logic"; the field of application is the hotel room: through a magnetic sensor installed on the door and connected to a digital input (also to the sensor itself), accurate presence information is managed. The presence detection solution can deduce the presence of people in the room using one or more dedicated sensors. It also detects an unexpected presence and is able to differentiate more behaviors.

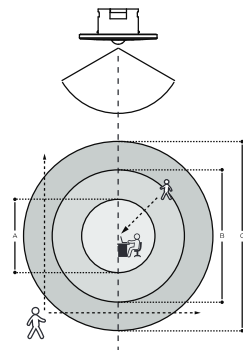

Detection range

BASIC - STANDARD - MULTI - SPACE			
h	A	B	C
2.5 m	3.8 m	7.0 m	10.0 m
3.0 m	4.0 m	8.0 m	12.0 m
3.5 m	5.0 m	9.0 m	13.0 m
4.0 m	6.0 m	11.0 m	14.0 m

- A | Person working at the desk
- B | Person moving towards the sensor
- C | Person moving sideways with respect to the sensor

Technical Features

Mechanical data	<ul style="list-style-type: none"> Dimensions: Ø x H 81 x 37 mm
Mounting	<ul style="list-style-type: none"> Ceiling mounting, flush-mounted, surface installation
Supply	<ul style="list-style-type: none"> Via bus EIB/KNX cable: 21 ÷ 32 Vdc
Input - digital mode	<ul style="list-style-type: none"> For free potential contacts (dry contacts) Max. length of Connecting Cables ≤ 30 m (twisted cable)
Input - analog mode for temperature probe	For NTC temperature probe eelectron code: <ul style="list-style-type: none"> TS01A01ACC (range from -20°C to +100°C) TS01B01ACC (range from -50°C to +60°C) TS01D01ACC (range from -40°C to 125°C) Max. length of Connecting Cable: ≤ 30 m (twisted cable)

Order Codes

- PD00E00KNX**
KNX Presence detector Basic
- PD00E00KNX-3**
KNX Presence detector Basic - Black
- PD00E00ACC**
Surface mounting enclosure
- PD00E00ACC-3**
Surface mounting enclosure - Black
- PD00E01ACC**
Box mounting frame
- PD00E03ACC**
Swiss box mounting frame - White
- PD00E03ACC-3**
Swiss box mounting frame - Black

KNX Standard Presence Detector

WITH LIGHTING CONTROL

The STANDARD version of Eelectron presence detectors range is suitable for ceiling mounting up to 4 m height and includes a brightness sensor for environmental lighting control. Presence detection, based on a passive infrared sensor, has 5 independently configurable channels with different functions that can be activated: presence with or without brightness control and with automatic or semi-automatic detection; constant brightness independent or presence dependent with automatic or semi-automatic activation.

The device has a rear connector with 3 digital inputs that can be connected to buttons or switches free of potential and used for on / off commands, dimming, shutters or blinds / scenarios, sequences, step commands, etc. One of the 3 inputs can be configured as analogue for the connection of NTC temperature probes (see eelectron probes code TS00A01ACC / TS00B01ACC) with which to send the temperature measurement on the bus. 12 logic blocks are available to implement simple expressions with logical or threshold operator or complex expressions with algebraic and conditional operators.

The device also integrates the "Virtual Holder Logic"; the field of application is the hotel room: through a magnetic sensor installed on the door and connected to a digital input (also to the sensor itself), accurate presence information is managed. The presence detection solution can deduce the presence of people in the room using one or more dedicated sensors. It also detects an unexpected presence and is able to differentiate more behaviors.

The device manages the ambient lighting based on the measured illuminance; it is also possible to enable the logic called "Circadian Rhythm" with which brightness and color temperature are imposed on the basis of predefined curves or on the basis of the real position of the sun during the day with respect to a terrestrial coordinate.

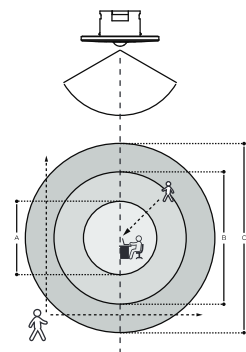

Detection range

BASIC - STANDARD - MULTI - SPACE			
h	A	B	C
2.5 m	3.8 m	7.0 m	10.0 m
3.0 m	4.0 m	8.0 m	12.0 m
3.5 m	5.0 m	9.0 m	13.0 m
4.0 m	6.0 m	11.0 m	14.0 m

- A | Person working at the desk
- B | Person moving towards the sensor
- C | Person moving sideways with respect to the sensor

Technical Features

Mechanical data	<ul style="list-style-type: none"> Dimensions: Ø x H 81 x 37 mm
Mounting	<ul style="list-style-type: none"> Ceiling mounting, flush-mounted, surface installation
Supply	<ul style="list-style-type: none"> Via bus EIB/KNX cable: 21 ÷ 32 Vdc
Input - digital mode	<ul style="list-style-type: none"> For free potential contacts (dry contacts) Max. length of Connecting Cables ≤ 30 m (twisted cable)
Input - analog mode for temperature probe	For NTC temperature probe eelectron code: <ul style="list-style-type: none"> TS01A01ACC (range from -20°C to +100°C) TS01B01ACC (range from -50°C to +60°C) TS01D01ACC (range from -40°C to 125°C) Max. length of Connecting Cable: ≤ 30 m (twisted cable)

Order Codes

- PD00E01KNX**
KNX Presence detector Standard with lighting control
- PD00E01KNX-3**
KNX Presence detector Standard with lighting control - Black
- PD00E00ACC**
Surface mounting enclosure
- PD00E00ACC-3**
Surface mounting enclosure - Black
- PD00E01ACC**
Box mounting frame
- PD00E03ACC**
Swiss box mounting frame - White
- PD00E03ACC-3**
Swiss box mounting frame - Black

KNX High Bay Presence Detector

WITH LIGHTING CONTROL

The HIGH BAY version of Eelectron presence detectors range is suitable for ceiling mounting up to 16 m height and includes a brightness sensor for environmental lighting control. Presence detection, based on a passive infrared sensor, has 5 independently configurable channels with different functions that can be activated: presence with or without brightness control and with automatic or semi-automatic detection; constant brightness independent or presence dependent with automatic or semi-automatic activation.

The device has a rear connector with 3 digital inputs that can be connected to buttons or switches free of potential and used for on / off commands, dimming, shutters or blinds / scenarios, sequences, step commands, etc. One of the 3 inputs can be configured as analogue for the connection of NTC temperature probes (see eelectron probes code TS00A01ACC / TS00B01ACC) with which to send the temperature measurement on the bus. 12 logic blocks are available to implement simple expressions with logical or threshold operator or complex expressions with algebraic and conditional operators.

The device also integrates the "Virtual Holder Logic"; the field of application is the hotel room: through a magnetic sensor installed on the door and connected to a digital input (also to the sensor itself), accurate presence information is managed. The presence detection solution can deduce the presence of people in the room using one or more dedicated sensors. It also detects an unexpected presence and is able to differentiate more behaviors.

The device manages the ambient lighting based on the measured illuminance; it is also possible to enable the logic called "Circadian Rhythm" with which brightness and color temperature are imposed on the basis of predefined curves or on the basis of the real position of the sun during the day with respect to a terrestrial coordinate.



Detection range

h	∅
5 m	6 m
12 m	14 m
16 m	19 m

Technical Features

Mechanical data	<ul style="list-style-type: none"> • Dimensions: ∅ × H 81 x 37 mm
Mounting	<ul style="list-style-type: none"> • Ceiling mounting, flush-mounted, surface installation
Supply	<ul style="list-style-type: none"> • Via bus EIB/KNX cable: 21 ÷ 32 Vdc
Input - digital mode	<ul style="list-style-type: none"> • For free potential contacts (dry contacts) • Max. length of Connecting Cables ≤ 30 m (twisted cable)
Input - analog mode for temperature probe	For NTC temperature probe eelectron code: <ul style="list-style-type: none"> • TS01A01ACC (range from -20°C to +100°C) • TS01B01ACC (range from -50°C to +60°C) • TS01D01ACC (range from -40°C to 125°C) • Max. length of Connecting Cable: ≤ 30 m (twisted cable)

Order Codes

PD00E09KNX

KNX High bay presence detector with lighting control

PD00E09KNX-3

KNX High bay presence detector with lighting control - Black

PD00E00ACC

Surface mounting enclosure

PD00E00ACC-3

Surface mounting enclosure - Black

PD00E01ACC

Box mounting frame

PD00E03ACC

Swiss box mounting frame - White

PD00E03ACC-3

Swiss box mounting frame - Black

KNX Multi.Sensor Presence Detector

WITH LIGHTING CONTROL, TEMPERATURE, HUMIDITY, SOUND SENSOR

The MULTI.SENSOR of Eelectron presence detectors range is suitable for ceiling mounting up to 4 m height. The device includes a brightness sensor for environmental lighting control, humidity and temperature sensors with the relative control algorithms and a sound sensor that can be used in rooms with parts not totally visible to the infrared sensor.

Presence detection, based on a passive infrared sensor, has 5 independently configurable channels with different functions that can be activated: presence with or without brightness control and with automatic or semi-automatic detection; constant brightness independent or presence dependent with automatic or semi-automatic activation.

The device has a rear connector with 3 digital inputs that can be connected to buttons or switches free of potential and used for on / off commands, dimming, shutters or blinds / scenarios, sequences, step commands, etc. One of the 3 inputs can be configured as analogue for the connection of NTC temperature probes (see eelectron probes code TS00A01ACC / TS00B01ACC) with which to send the temperature measurement on the bus or manage a complete thermostat module. The thermostat manages 2 stages with an integrated PI controller for controlling heating and cooling equipment, valves, 2 and 4-pipe fan coils, etc.

The humidity sensor manages the measurement of the ambient relative humidity and allows the control with thresholds and hysteresis of humidification and dehumidification equipments.

12 logic blocks are available to implement simple expressions with logical or threshold operator or complex expressions with algebraic and conditional operators. The device also integrates the "Virtual Holder Logic"; the field of application is the hotel room: through a magnetic sensor installed on the door and connected to a digital input (also to the sensor itself), accurate presence information is managed. The presence detection solution can deduce the presence of people in the room using one or more dedicated sensors. It also detects an unexpected presence and is able to differentiate more behaviors. The device manages the ambient lighting based on the measured illuminance; it is also possible to enable the logic called "Circadian Rhythm" with which brightness and color temperature are imposed on the basis of predefined curves or on the basis of the real position of the sun during the day with respect to a terrestrial coordinate.

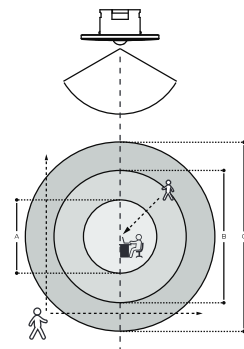

BASIC - STANDARD - MULTI - SPACE

h	A	B	C
2.5 m	3.8 m	7.0 m	10.0 m
3.0 m	4.0 m	8.0 m	12.0 m
3.5 m	5.0 m	9.0 m	13.0 m
4.0 m	6.0 m	11.0 m	14.0 m

- A | Person working at the desk
- B | Person moving towards the sensor
- C | Person moving sideways with respect to the sensor

Technical Features

Mechanical data	<ul style="list-style-type: none"> Dimensions: Ø x H 81 x 37 mm
Mounting	<ul style="list-style-type: none"> Ceiling mounting, flush-mounted, surface installation
Supply	<ul style="list-style-type: none"> Via bus EIB/KNX cable: 21 ÷ 32 Vdc
Input - digital mode	<ul style="list-style-type: none"> For free potential contacts (dry contacts) Max. length of Connecting Cables ≤ 30 m (twisted cable)
Input - analog mode for temperature probe	For NTC temperature probe eelectron code: <ul style="list-style-type: none"> TS01A01ACC (range from -20°C to +100°C) TS01B01ACC (range from -50°C to +60°C) TS01D01ACC (range from -40°C to 125°C) Max. length of Connecting Cable: ≤ 30 m (twisted cable)

Order Codes

PD00E02KNX

KNX Presence detector Multi.Sensor - lighting control, temperature, humidity, sound sensor

PD00E02KNX-3

KNX Presence detector Multi.Sensor - lighting control, temperature, humidity, sound sensor - Black

PD00E00ACC

Surface mounting enclosure

PD00E00ACC-3

Surface mounting enclosure - Black

PD00E01ACC

Box mounting frame

SM03E01ACC

Slave sensor CO₂ + Temperature

SM03E01ACC-3

Slave sensor CO₂ + Temperature - Black

PD00E03ACC

Swiss box mounting frame - White

PD00E03ACC-3

Swiss box mounting frame - Black

KNX Space Presence Detector

WITH LIGHTING CONTROL, TEMPERATURE, HUMIDITY, SOUND SENSOR, UTILIZATION RANGE AND OCCUPANCY

The SPACE sensor of Eelectron presence detectors range is suitable for ceiling mounting up to 4 m height. The device includes a brightness sensor for environmental lighting control, humidity and temperature sensors with the relative control algorithms and a sound sensor that can be used in rooms with parts not totally visible to the infrared sensor. Presence detection, based on a passive infrared sensor, has 5 independently configurable channels with different functions that can be activated: presence with or without brightness control and with automatic or semi-automatic detection; constant brightness independent or presence dependent with automatic or semi-automatic activation. The device has a rear connector with 3 digital inputs that can be connected to buttons or switches free of potential and used for on / off commands, dimming, shutters or blinds / scenarios, sequences, step commands, etc. One of the 3 inputs can be configured as analogue for the connection of NTC temperature probes (see eelectron probes code TS00A01ACC / TS00B01ACC) with which to send the temperature measurement on the bus or manage a complete thermostat module. The thermostat manages 2 stages with an integrated PI controller for controlling heating and cooling equipment, valves, 2 and 4-pipe fan coils, etc. The humidity sensor manages the measurement of the ambient relative humidity and allows the control with thresholds and hysteresis of humidification and dehumidification equipments. 12 logic blocks are available to implement simple expressions with logical or threshold operator or complex expressions with algebraic and conditional operators. The device also integrates the "Virtual Holder Logic"; the field of application is the hotel room: through a magnetic sensor installed on the door and connected to a digital input (also to the sensor itself), accurate presence information is managed. The presence detection solution can deduce the presence of people in the room using one or more dedicated sensors. It also detects an unexpected presence and is able to differentiate more behaviors. The device manages the ambient lighting based on the measured illuminance; it is also possible to enable the logic called "Circadian Rhythm" with which brightness and color temperature are imposed on the basis of predefined curves or on the basis of the real position of the sun during the day with respect to a terrestrial coordinate.

To further integrate presence detection, the **Utilization function** can enable functionalities for mapping space status and related usage/availability i.e. space occupancy and % of utilization rates and can be used to create dashboards, analytics, etc. Moreover, the integrated **Occupancy function** detects useful data for the processing of information related to the intensity of the activity of occupants within the monitored areas allowing the generation of a "heat map" of the building areas.

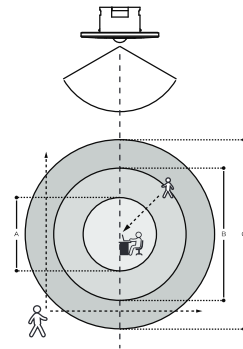

BASIC - STANDARD - MULTI - SPACE			
h	A	B	C
2.5 m	3.8 m	7.0 m	10.0 m
3.0 m	4.0 m	8.0 m	12.0 m
3.5 m	5.0 m	9.0 m	13.0 m
4.0 m	6.0 m	11.0 m	14.0 m

- A | Person working at the desk
- B | Person moving towards the sensor
- C | Person moving sideways with respect to the sensor

Technical Features

Mechanical data	<ul style="list-style-type: none"> Dimensions: Ø x H 81 x 37 mm
Mounting	<ul style="list-style-type: none"> Ceiling mounting, flush-mounted, surface installation
Supply	<ul style="list-style-type: none"> Via bus EIB/KNX cable: 21 ÷ 32 Vdc
Input - digital mode	<ul style="list-style-type: none"> For free potential contacts (dry contacts) Max. length of Connecting Cables ≤ 30 m (twisted cable)
Input - analog mode for temperature probe	For NTC temperature probe eelectron code: <ul style="list-style-type: none"> TS01A01ACC (range from -20°C to +100°C) TS01B01ACC (range from -50°C to +60°C) TS01D01ACC (range from -40°C to 125°C) Max. length of Connecting Cable: ≤ 30 m (twisted cable)

Order Codes

PD00E03KNX

KNX Presence detector Space - lighting control, temperature, humidity, sound sensor, utilization range and occupancy

PD00E03KNX-3

KNX Presence detector Space - lighting control, temperature, humidity, sound sensor, utilization range and occupancy - Black

PD00E00ACC

Surface mounting enclosure

PD00E00ACC-3

Surface mounting enclosure - Black

PD00E01ACC

Box mounting frame

SM03E01ACC

Slave sensor CO₂ + Temperature

SM03E01ACC-3

Slave sensor CO₂ + Temperature - Black

PD00E03ACC

Swiss box mounting frame - White

PD00E03ACC-3

Swiss box mounting frame - Black

KNX Wide Range Presence Detector

WITH LIGHTING CONTROL

The device KNX Wide Range (PD00E20KNX) is an extended range presence and motion sensor suitable for use in indoor environments where a wide range coverage is required. It is equipped with a rear connector with 2 digital inputs that can be connected to potential-free buttons or switches and used for on / off, dimming, rolling shutters or blinds / scenarios, sequences, step-by-step commands, etc. The second input can be configured as analog for the connection of NTC temperature probes (see probes eelectron code TS00A01ACC / TS00B01ACC) to send the temperature measurement on the bus or manage a complete thermostat module. The thermostat manages 2 stages with integrated PI controller for driving heating and cooling equipment, valves, 2 and 4 pipe fan coils, etc.

Presence detection, based on a passive infrared sensor, has 5 independently configurable channels with different functions that can be activated: presence with or without brightness control and with automatic or semi-automatic detection; constant brightness independent or presence dependent with automatic or semi-automatic activation. The PD00E20KNX Wide Range sensor uses 3 distinct sensing elements; by means of the ETS parameterization it is possible to assign different behaviors to the different elements.

Moreover, 12 logic blocks are available to implement simple expressions with logical or threshold operator or complex expressions with algebraic and conditional operators; It's possible to use predefined algorithms as proportional controls of temperature and humidity or dew point calculation. The device also integrates the "Virtual Holder Logic" and it is also possible to enable the logic called "Circadian Rhythm".

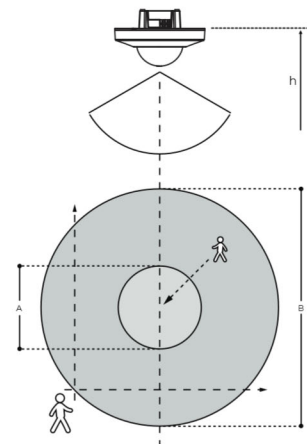

A	h = 2.5 m	B	h = 2.5 m
	ø = 7 m		ø = 24 m

A | Person working at the desk
B | Person moving towards the sensor

Technical Features

Mechanical data	<ul style="list-style-type: none"> Dimensions: Ø x H 105 x 66.5 mm
Mounting	<ul style="list-style-type: none"> Ceiling mounting, flush-mounted, surface installation
Supply	<ul style="list-style-type: none"> Via bus EIB/KNX cable: 21 ÷ 32 Vdc
Input - digital mode	<ul style="list-style-type: none"> For free potential contacts (dry contacts) Max. length of Connecting Cables ≤ 30 m (twisted cable)
Input - analog mode for temperature probe	<p>For NTC temperature probe eelectron code:</p> <ul style="list-style-type: none"> TS01A01ACC (range from -20°C to +100°C) TS01B01ACC (range from -50°C to +60°C) TS01D01ACC (range from -40°C to 125°C) Max. length of Connecting Cable: ≤ 30 m (twisted cable)

Order Codes

- PD00E20KNX**
KNX Wide Range Presence detector - lighting control
- PD00E20KNX-3**
KNX Wide Range Presence detector - lighting control - Black
- PD00E00ACC**
Surface mounting enclosure
- PD00E00ACC-3**
Surface mounting enclosure - Black
- PD00E01ACC**
Box mounting frame
- SM03E01ACC**
Slave sensor CO₂ + Temperature
- SM03E01ACC-3**
Slave sensor CO₂ + Temperature - Black
- PD00E03ACC**
Swiss box mounting frame - White
- PD00E03ACC-3**
Swiss box mounting frame - Black

KNX Corridor Presence Detector

WITH LIGHTING CONTROL

The device KNX Corridor (PD00E21KNX) is an extended range presence and motion sensor for corridors suitable for use in indoor environments where a wide range coverage is required. It is equipped with a rear connector with 2 digital inputs that can be connected to potential-free buttons or switches and used for on / off, dimming, rolling shutters or blinds/scenarios, sequences, step-by-step commands, etc. The second input can be configured as analog for the connection of NTC temperature probes (see probes electron code TS00A01ACC / TS00B01ACC) to send the temperature measurement on the bus or manage a complete thermostat module. The thermostat manages 2 stages with integrated PI controller for driving heating and cooling equipment, valves, 2 and 4 pipe fan coils, etc.

Presence detection, based on a passive infrared sensor, has 5 independently configurable channels with different functions that can be activated: presence with or without brightness control and with automatic or semi-automatic detection; constant brightness independent or presence dependent with automatic or semi-automatic activation. The PD00E21KNX Wide Range sensor uses 2 distinct sensing elements; by means of the ETS parameterization it is possible to assign different behaviors to the different elements.

Moreover, 12 logic blocks are available to implement simple expressions with logical or threshold operator or complex expressions with algebraic and conditional operators; It's possible to use predefined algorithms as proportional controls of temperature and humidity or dew point calculation. The device also integrates the "Virtual Holder Logic" and it is also possible to enable the logic called "Circadian Rhythm".

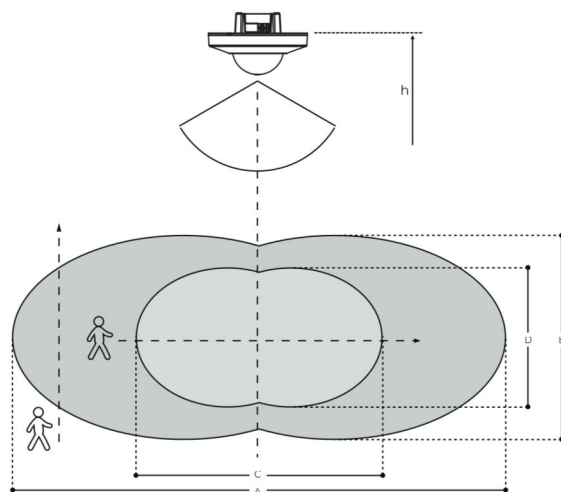

A	40 m	B	5 m
h	2.5 m	h	2.5 m
C	16 m	D	3 m
h	2.5 m	h	2.5 m

Technical Features

Mechanical data	<ul style="list-style-type: none"> Dimensions: Ø × H 105 × 66.5 mm
Mounting	<ul style="list-style-type: none"> Ceiling mounting, flush-mounted, surface installation
Supply	<ul style="list-style-type: none"> Via bus EIB/KNX cable: 21 ÷ 32 Vdc
Input - digital mode	<ul style="list-style-type: none"> For free potential contacts (dry contacts) Max. length of Connecting Cables ≤ 30 m (twisted cable)
Input - analog mode for temperature probe	For NTC temperature probe electron code: <ul style="list-style-type: none"> TS01A01ACC (range from -20°C to +100°C) TS01B01ACC (range from -50°C to +60°C) TS01D01ACC (range from -40°C to 125°C) Max. length of Connecting Cable: ≤ 30 m (twisted cable)

Order Codes

- PD00E21KNX**
KNX Corridor Presence detector - lighting control
- PD00E21KNX-3**
KNX Corridor Presence detector - lighting control - Black
- PD00E00ACC**
Surface mounting enclosure
- PD00E00ACC-3**
Surface mounting enclosure - Black
- PD00E01ACC**
Box mounting frame
- SM03E01ACC**
Slave sensor CO₂ + Temperature
- SM03E01ACC-3**
Slave sensor CO₂ + Temperature - Black
- PD00E03ACC**
Swiss box mounting frame - White
- PD00E03ACC-3**
Swiss box mounting frame - Black

Conventional Presence Detector

2 CH. CEILING MOUNTING PIR DETECTOR

The device is a ceiling flush mount PIR detector. The load will be switched on automatically when the movement is detected and the ambient light level is below the Lux setting value. Until there is no movement detected and the pre-set delay time has been expired, load will be switched off automatically. User can pre-set the desired Lux and Time values by VR or IR setting for automatic control lighting on / off with low initial cost and great energy saving potential. Can also be used in many different places for automation control. It can be widely used in home, office, conference room, classrooms, hotel, corridor, underground parking lots, etc.



Technical Features

Mechanical data	<ul style="list-style-type: none"> • Dimensions: (H x W x D): 64x80x80 mm
Mounting	<ul style="list-style-type: none"> • Ceiling mounting, surface installation
Range	<ul style="list-style-type: none"> • Up to Ø12 m at height of 2.5 m • Operating temperature: 20° C to +50° C
Output rate CH1 - for lighting	<ul style="list-style-type: none"> • Incandescent Lamp: Max. 2000 W • AC Halogen Lamp: Max. 1000 W • LV Halogen Lamp: Max. 1000 VA / 600 W (traditional Max. 1000VA / 900 W (electronics)) • Fluorescent Lamp: <ul style="list-style-type: none"> - Max. 1000 VA / 600 W (uncompensated) - Max. 900 VA / 100 µF - 25 x (1 x 18 W); 12 x (2 x 18 W); - 15 x (1 x 36 W); 7 x (2 x 36 W); - 10 x (1 x 58 W); 5 x (2 x 58 W) • LED Lamp : Max. 400 W • Energy Saving Lamp: Max. 600 VA / 400 W (include CFL and PL lamp)
Output rate CH2 - for Automation Control	<ul style="list-style-type: none"> • (Lux is invalid): <ul style="list-style-type: none"> - Max. 5 A (cos φ = 1) for 250 Vac - Max. 5 A for 30 Vdc - Max. 1 A (cos φ = 0.4) for 250 Vac

Order Codes

PD02X01CON

2 Ch. ceiling mounting PIR detector
230V AC – ø 12m

PD02X01ACC

Surface mounting enclosure

PD02X02CON

2 Ch. ceiling mounting PIR detector
230V AC – ø 24 m

Plug In Sensor CO₂ + Temperature

The code SM03E01ACC identifies the accessory of the devices code:
 PD00E02KNX – KNX MULTI presence detector – lighting, temperature, humidity, sound.
 PD00E03KNX – KNX Space presence detector- lighting, temperature, humidity, sound , occupancy and utilization.
 PD00E20KNX – wide range presence detector with lighting control.
 PD00E21KNX – presence detector for corridor with lighting control.

This accessory includes a temperature probe (range from -5 ° C to +50 ° C) and a CO₂ sensor.



Technical Features

Mechanical data	<ul style="list-style-type: none"> • Dimensions: Ø × H 81 x 37 mm
Mounting	<ul style="list-style-type: none"> • Ceiling mounting, flush-mounted, surface installation
Supply	<ul style="list-style-type: none"> • Aux supply: 9 ÷ 32 Vdc 9 ÷ 24 Vac
Input - digital mode	<ul style="list-style-type: none"> • For free potential contacts (dry contacts) • Max. length of Connecting Cables ≤ 30 m (twisted cable)
Input - analog mode for temperature probe	<p>For NTC temperature probe eelectron code:</p> <ul style="list-style-type: none"> • TS01A01ACC (range from -20°C to +100°C) • TS01B01ACC (range from -50°C to +60°C) • TS01D01ACC (range from -40°C to 125°C) • Max. length of Connecting Cable: ≤ 30 m (twisted cable)

Order Codes

SM03E01ACC

Slave sensor CO₂ + Temperature

SM03E01ACC-3

Slave sensor CO₂ + Temperature - Black

PD00E00ACC

Surface mounting enclosure

PD00E00ACC-3

Surface mounting enclosure - Black

PD00E01ACC

Box mounting frame

PD00E03ACC

Swiss box mounting frame - White

PD00E03ACC-3

Swiss box mounting frame - Black

Plug In Sensor VOC + CO₂ + eCO₂ + Temperature

The code SM03E02ACC identifies the accessory of the devices code: PD00E02KNX – KNX MULTI presence detector – lighting, temperature, humidity, sound. PD00E03KNX – KNX Space presence detector- lighting, temperature, humidity, sound , occupancy and utilization.

PD00E20KNX – wide range presence detector with lighting control.

PD00E21KNX – presence detector for corridor with lighting control.

This accessory includes a temperature probe (range from -5 ° C to + 50 ° C) and a CO₂ sensor.



Technical Features

Mechanical data	<ul style="list-style-type: none"> • Dimensions: Ø × H 81 x 37 mm
Mounting	<ul style="list-style-type: none"> • Ceiling mounting, flush-mounted, surface installation
Supply	<ul style="list-style-type: none"> • Aux supply: 9 ÷ 32 Vdc 9 ÷ 24 Vac
Input - digital mode	<ul style="list-style-type: none"> • For free potential contacts (dry contacts) • Max. length of Connecting Cables ≤ 30 m (twisted cable)
Input - analog mode for temperature probe	For NTC temperature probe eelectron code: <ul style="list-style-type: none"> • TS01A01ACC (range from -20°C to +100°C) • TS01B01ACC (range from -50°C to +60°C) • TS01D01ACC (range from -40°C to 125°C) • Max. length of Connecting Cable: ≤ 30 m (twisted cable)

Order Codes

SM03E02ACC

Slave sensor CO₂ + Temperature

SM03E02ACC-3

Slave sensor CO₂ + Temperature - Black

PD00E00ACC

Surface mounting enclosure

PD00E00ACC-3

Surface mounting enclosure - Black

PD00E01ACC

Box mounting frame

PD00E03ACC

Swiss box mounting frame - White

PD00E03ACC-3

Swiss box mounting frame - Black

Energy Meter

SINGLE PHASE - MID

The device PM10E02IRE – Single-phase Digital Energy meter – Direct connection 80 A integrates all the measurement functions necessary to monitor a single-phase electrical installation:

- 0.25-5 (80) A, Class B, 230 VAC 50 Hz, -25 °C ÷ +55 °C, 4 Quadrants, 2 Tariffs
- Active Energy Class B (according to EN-50470) and Reactive Energy Class 2 (according to IEC 62053-23)
- Direct connected (up to 80 A)
- Backlightet LCD display and 3 push-button keys (to read Energies, V, I, PF, F, P, Q and to configure some parameters)
- Display with 8 digits.
- Self supplied (by the input voltage itself)
- DIN modules width (36 mm)
- 2 Tariffs controlled by a 230 VAC digital input
- 2 S0 standard low voltage pulse outputs MID certified



Technical Features

Mechanical data	<ul style="list-style-type: none"> • Dimensions: 2 DIN Modules (PM10E02IRE) • Dimensions: 1 DIN Module (PM00A00IRI)
Supply	<ul style="list-style-type: none"> • Via bus EIB/KNX cable: 21 ÷ 32 Vdc • Operating supply voltage range: 92 ÷ 276 Vac • Reference current 5 A / max current 63A / min. current 0,25 A / starting current 0,015 A • Nominal frequency 50 Hz / frequency range: 45 ÷ 65 Hz • Max Power consumption (voltage circuit) < 2VA (1 W)
Functionality	<ul style="list-style-type: none"> • Connection to single-phase network (2-wires) • Tariff for active and reactive energy: n° 2 - T1 / T2
Overload capability	<ul style="list-style-type: none"> • Permanent voltage 276 Vac / temporary (1 s) 300 Vac • Permanent current 63 A / temporary (10 ms) 1890 A
Protective class	Class II

Order Codes

PM10E02IRE

Single-phase Digital Energy meter – Direct connection 80 A – MID

PM00A00IRI

EIB-KNX interface

Energy Meter

ENERGY METER **THREE-PHASE ENERGY METER 80 A – MID**
 ENERGY METER **THREE PHASE WITH EXTERNAL TA 1-5A – MID**

Devices provide all relevant measures for the evaluation of an electrical network: I, U, PF, F, THD%, Powers (displayed for each phase and 3 phase), and Imported/Exported Active/Reactive Energies.

- Direct connection (80 A)
- Current range 0.25-5(80) A
- 2 tariffs and with IR lateral communication available
- 2 S0 Pulse outputs **MID certified**

Devices are intended to be installed on DIN rail.



Technical Features

Mechanical data	<ul style="list-style-type: none"> • Dimensions: 4 DIN Modules • Dimensions: 1 DIN Module
Supply	<ul style="list-style-type: none"> • Via bus EIB/KNX cable: 21 ÷ 32 Vdc • Reference voltage Line to Neutral: 230 Vac • Reference voltage Line to Line: 400 Vac • Operating supply voltage range: 92 ÷ 276 / 160 ÷ 480 Vac • cod. PM30E01IRE: reference current 5 A / maximum current 63 A / minimum current 0.25 A / starting current 0.015 A • cod. PM30E02IRE: reference current 1 A / maximum current 6 A / minimum current 0.01 A / starting current 0.001 A • cod. PM30E02IRE: max CT ratio 10000/5 A or 2000/1 A; ratio adjusting step 5 or 1 A • Nominal frequency 50 A / frequency range: 45 ÷ 65 Hz • Max Power consumption (voltage circuit) ≤2 VA (0.6 W)
Functionality	<ul style="list-style-type: none"> • Connection to three-phase network (4-wires) • Tariff for active energy: n° 2 - T1 / T2
Overload capability	<p>Voltage:</p> <ul style="list-style-type: none"> • continuous phase-phase 480 Vac • 1 second phase-phase 800 Vac • cod. PM30E01IRE: continuous phase-N 276 Vac • cod. PM30E02IRE: continuous phase-N 800 Vac • 1 second phase-N 300 Vac <p>Current:</p> <ul style="list-style-type: none"> • cod. PM30E01IRE: <ul style="list-style-type: none"> - continuous 80 A - 10ms 2400 A • cod. PM30E02IRE: <ul style="list-style-type: none"> - continuous 6 A - 0,5 ms 120 A

Order Codes

PM30E01IRE

Three-phase Digital Energy Meter Direct connection 80 A – MID

PM30E02IRE

Three-phase Digital Energy Meter with external TA 1-5 A – MID

PM00A00IRI

EIB-KNX interface

KNX Time / Astronomical Master

ES01A00KNX is a digital electronic switch for time management of electrical utilities. It allows time programming (daily, weekly or yearly) or astronomical. ES01A00KNX can control 9 different channels on bus KNX. The programming of channel 1 is also replicated on the relay located on the device. Each channel can be associated with a different programming (time or astronomical). ES01A00KNX also offers the possibility of connecting via BUS a GPS module, ES01A00ACC (available as an accessory), which allows the acquisition of the time and the position through the satellite system, ensuring greater accuracy over time. The backup battery allows you to keep the settings even in case of blackout and can be replaced through the cover (sealable).



Technical Features

Mechanical data	<ul style="list-style-type: none"> • Dimensions: 3 DIN Modules
Supply	<ul style="list-style-type: none"> • Via bus EIB/KNX cable: 21 ÷ 32 Vdc • Auxiliary supply: 115 ÷ 230 Vac 50/60 Hz
Output rate	<ul style="list-style-type: none"> • Capacity at 250 Vac 16 A • Lamp loads • Incandescent lamps 2000 W • Fluorescent lamps (compensated) 250 VA • Low voltage halogen lamps 11000 VA • Halogen lamps at 240 V 2000 W • Low consumption lamps (CFL) 200 VA • Low consumption lamps (Downlights) 200 VA • LED 25 VA

Order Codes

ES01A00KNX
KNX time/astronomical master

ES01A00ACC
Additional GPS module

Bridge

KNX BRIDGE WITH IP INTERFACE AND POWER SUPPLY

The IPSBA01KNX device integrates a KNX power supply with auxiliary output with a total current of 640mA, and an IP interface, allowing KNX installations to be implemented quickly and efficiently. Device can be linked to a Cloud platform, through MQTT protocol, and share relevant data detected from connected KNX devices. The voltage of the bus output as well as that of the auxiliary output is 30V DC. The device is compact having a size of only 4 DIN modules. The KNX IP interface allows you to connect a KNX network to an IP backbone; the IP address can be obtained via DHCP server or manually configured via ETS®. The device works in accordance with the KNXnet / IP specifications; up to 5 different IP addresses can be assigned. The device is also a KNX bus node, with its own application program and can be configured with ETS® to communicate using KNX Data Secure protocol. Logic blocks are available to implement simple expressions with logical or threshold operator or complex expressions with algebraic and conditional operators; It's possible to use predefined algorithms as proportional controls of temperature and humidity or dew point calculation. The device also integrates the "Virtual Holder Logic"; the field of application is the hotel room: through a magnetic sensor installed on the door and connected to a digital input (also to the sensor itself), accurate presence information is managed. The presence detection solution can deduce the presence of people in the room using one or more dedicated sensors. It also detects an unexpected presence and is able to differentiate more behaviors. It is also implemented the control logic called "OnLine-OffLine" that checks all KNX TP devices of the subnet connected to the power supply are operating "On Line", alerting the backbone if one of them goes into "Off Line" status. On the device there are pushbuttons and signaling LEDs for bus reset operations as well as for Factory Reset or for displaying activity on the KNX bus and on the IP backbone. The device is intended for installation on DIN bar in LV distribution switchboards.



Technical Features

Mechanical data	<ul style="list-style-type: none"> • Dimensions: 4 DIN Modules
Supply	<ul style="list-style-type: none"> • Input voltage: 180 ..264 V AC, 50/60 Hz • Output voltage: DC 30 V (SELV) • Output current: 640 mA (KNX+AUX)

Order Codes

IPSBA01KNX

KNX Bridge with IP interface and KNX-+AUX power supply 640mA

Power Supply

640 mA

Power supply for generating bus voltage on a line with a maximum current of 640 mA. With integrated choke to decouple the power supply voltage from the bus. Connection with screw terminals.

Mounting on DIN rails EN 50022. Bus connection via bus terminal.



Technical Features

Mechanical data	<ul style="list-style-type: none"> • Dimensions: 3 DIN Modules
Supply	<ul style="list-style-type: none"> • Input voltage: 180 ÷ 264 Vac • Output voltage: Rated voltage 30 Vdc • Output current: Rated current 640 mA

Order Codes

PS00D03KNX
640 mA Power Supply

Power Supply

640 mA

The power supply unit PS00E03KNX provides the system power necessary for the KNX/EIB bus. The connection to the bus line is via the bus connection block located on the front side. The integrated choke prevents the data telegrams from short-circuiting on the bus line. When the built-in reset button is operated, the bus devices are returned to their initial state. For each bus line, at least one power supply unit PS00E03KNX is needed. Up to two power supply units may be attached to a single bus line. The distance between power supply unit PS00E03KNX and any of its bus devices must not exceed 350 m. The power supply unit PS00E03KNX has a voltage and current regulation and is therefore short-circuit proof. Short power failures can be bridged with a backup interval of approximately 200ms. The power supply unit PS00E03KNX can supply 30 Vdc power from an additional pair of terminals.



Technical Features

Mechanical data	<ul style="list-style-type: none"> • Dimensions: 5 DIN Modules
Supply	<ul style="list-style-type: none"> • Input voltage: 180 ÷ 264 Vac • Output voltage: Rated voltage 30 Vdc • Output current: Rated current 640 mA

Order Codes

PS00E03KNX
640 mA Power Supply

Power Supply

1280 mA

The power supply unit PS00D04KNX provides the system power necessary for the KNX/EIB bus. The connection to the bus line is via the bus connection block located on the front side. The integrated choke prevents the data telegrams from short-circuiting on the bus line. When the built-in reset button is operated (press the RESET button for at least 20 seconds to reset the KNX Bus), the bus devices are returned to their initial state. For each bus line, at least one power supply unit PS00D04KNX is needed. Up to two power supply units may be attached to a single bus line. The distance between power supply unit PS00D04KNX and any of its bus devices must not exceed 350 m. The power supply unit PS00D04KNX has a voltage and current regulation and is therefore short-circuit proof. Short power failures can be bridged with a backup interval of approximately 200 ms. The power supply unit PS00D04KNX can supply DC 30 V power from an additional pair of terminals.



Technical Features

Mechanical data

- Dimensions: 4 DIN Modules

Supply

- Input voltage: AC 180 ÷ 264 V, 50 / 60 Hz
- Output voltage: DC 30 V (SELV)
- Output current: 1280 mA

Order Codes

PS00D04KNX
1280 mA Power Supply

KNX IP Interface KNX Secure

INTERFACE

The KNX IP Interface IN00S01IPI is a compact interface used to connect a PC to the KNX network. The connection is made through LAN (IP). Power is supplied via the KNX bus. The IP address can be obtained by a DHCP server or by manual configuration (ETS®) respectively. This device works according to the KNXnet/IP specification using the core, the device management and the tunneling part. The device supports KNX Security which can be enabled in ETS. With its interface functionality (tunneling) KNX security prevents from unauthorized access. The buttons are for diagnostic purposes. The LEDs indicate the operating status and communication errors on the bus.



Technical Features

Mechanical data	<ul style="list-style-type: none"> • Dimensions: 1 DIN Modules
Supply	<ul style="list-style-type: none"> • Via bus EIB/KNX cable: 21 ÷ 32 Vdc
Lan connection	<ul style="list-style-type: none"> • RJ-45 socket • Up to 8 simultaneous tunneling connection

Order Codes

IN00S01IPI
IP-KNX Interface KNX Secure

IP Router-KNX Secure

INTERFACE

With the KNX / IP router, a bidirectional communication among more KNX bus lines is possible through LAN networks. If the device is connected to a PC with an appropriate software (for example, ETS), it can also be used like a programming interface for KNX bus system. The IP address can be dynamically assigned via a DHCP server, or manually configured using ETS parameters. Communications are made in accordance with KNXnet / IP specifications. During the data transfer, it is possible to configure a filter table and keep up to 150 messages in the “buffer” memory.



Technical Features

Mechanical data	<ul style="list-style-type: none"> • Dimensions: 1 DIN Modules
Supply	<ul style="list-style-type: none"> • Via bus EIB/KNX cable: 21 ÷ 32 Vdc
Lan connection	<ul style="list-style-type: none"> • RJ-45 socket • Up to 8 simultaneous tunneling connection

Order Codes

IN00S01RIP
Router IP-KNX Interface KNX Secure

Line Coupler

KNX

The LC00B01KNX KNX line coupler has been made in a compact design. It connects two KNX bus segments (for example, a KNX line with a KNX area). The device has a filter table (8k bytes) and ensures a galvanic isolation between the lines. The coupler supports KNX long frames and is compatible with the ETS® software (ETS 4.2 or higher).

The buttons on the front panel allow disabling the telegram filter for testing purposes. The LEDs indicate operating conditions as well as communication errors on the KNX bus.



Technical Features

Mechanical data	<ul style="list-style-type: none"> • Dimensions: 1 DIN Modules
Supply	<ul style="list-style-type: none"> • Via bus EIB/KNX cable: 21 ÷ 32 Vdc

Order Codes

LC00B01KNX
Line Coupler KNX

USB-KNX

INTERFACE

The device enables the KNX bus system to be interfaced to a PC equipped with a port for programming or managing through appropriate software.



Technical Features

Mechanical data	<ul style="list-style-type: none"> • Dimensions: 1 DIN Modules
Supply	<ul style="list-style-type: none"> • Via bus EIB/KNX cable: 21 ÷ 32 Vdc • USB consumption: < 15 mA
USB Connection	<ul style="list-style-type: none"> • Connector type B • Max. cable length: 5 m

Order Codes

IN00A03USB
USB-KNX Interface

KNX

BUS CABLE

It is used for installation in “smart” building applications. Guarantees perfect communication in accordance with specifications established by EIB / KNX, and is suitable for applications with fixed wiring inside channels and under plaster.



Technical Features

Inner Conductor	<ul style="list-style-type: none"> • Solid bare copper wire
Construction	<ul style="list-style-type: none"> • 1 x 2 x 0,8 or 2 x 2 x 0,8 mm
Dielectric	<ul style="list-style-type: none"> • Low smoke zero halogen fire retardant compound (LSZHFRNC)
Colours	<ul style="list-style-type: none"> • Red, black or red, black, yellow, white
Outer Jacket	<ul style="list-style-type: none"> • Low smoke zero halogen fire retardant compound (LSZHFRNC)
Classified	<ul style="list-style-type: none"> • CEI 20-11 M1
According to	<ul style="list-style-type: none"> • IEC 60332-1, IEC 61034-1= IEC 61034-2
Diameter	<ul style="list-style-type: none"> • 5,20 mm ± 0,20 colour
Colour	<ul style="list-style-type: none"> • Green (RAL 6018)

Order Codes

CV00A01KNX

Double-bus cable 2x2x0, 8 coils 100 m

CV05A02KNX

Single bus cable 1x2x0, 8 coils 500 m

Miniature LED Lamps

3V BLUE OR WHITE

Packages of 20 or 60 pcs LED with Blue or White light 3 V wired red/black.



Technical Features

Dimension	<ul style="list-style-type: none"> • 3 mm x 4.3 mm (width and height) and 3.85 mm (radius) • Current: 20 mA • Reverse Voltage: 5 V • Luminous Intensity: 4000 Min - Max 9000 mcd
------------------	--

Order Codes

LD00A01ACC

Miniature LED Lamps Blue 3 V 20 pcs

LD00A11ACC

Miniature LED Lamps White 3 V 20 pcs

KNX Connector

RED / BLACK

BUS Connector Red / Black for EIB / KNX, with direct plug connection. They can be connected up to 4 pairs of wires to a KNX device, it can also be used as a branch terminal.



Technical Features

Dimension	<ul style="list-style-type: none"> • (H. x W. x D.) 11.5 x 10 x 10 mm
Features	<ul style="list-style-type: none"> • Wire 22 to 18 AWG (0.6 - 1 mm) • EN detected voltage 100 V • Rated current 6 A • Stripping length from 5 to 6 mm

Order Codes

WG00A01ACC
KNX Connector Red / Black Box 100 pcs

Temperature Probe

INTERNAL/ EXTERNAL



Order Codes

TS01A04ACC
Temperature probe
4 pcs

TS01B04ACC
External temperature probe
4 pcs



Eelectron spa
Via Monteverdi 6 | 20025 Legnano (MI) - Italia
Tel: +39 0331 500802
Email: info@eelectron.com
Web: www.eelectron.com

